



GAS COMPONENTS



ELECTRIC COMPONENTS



WATER TECHNOLOGY



MECHANICAL COMPONENTS



TOOLS

Spare parts suitable for

DESMON

Find the complete and up-to-date range of products in our GEV Webshop



Manufacturer catalogue

The most important spare parts and accessories arranged clearly for every manufacturer

- ✓ Complete product range and all appliance data always up to date in the GEV Webshop
- ✓ Alphabetical Index at the end of the catalogue

GEV Webshop

www.gev-online.co.uk

www.gev-online.com



- 🔍 Add to Favourites
- 🔍 Sign In with email address and usual password
- 🔍 Easy-order – place several items in your basket at the same time
- 🔍 Quick Item search – no login needed



heating elements

heating elements for refrigeration

heating elements for defrosting



1

GEV No.	417587	Ref. No.	R35-0070
description	heating element 350W 230V L 380mm Wmm Hmm cable length 3.3m tube ø 8.7mm		
For models:	ET 151		

heating elements for condensate evaporation



1

GEV No.	420241	Ref. No.	R35-0123
description	heating element 750W 230V L 415mm W 100mm H 95mm cable length 1500mm connection cable tube ø 6mm refrigeration		

condensing trays heated



1

GEV No.	695271	Ref. No.	Q32-0196 Q32-0196L
description	condensing tray heated L 410mm W 300mm H 80mm 230V 230W		
For models:	ID140		



1

GEV No.	750212	Ref. No.	89020710
description	condensing tray with heating cable for evaporator L 875mm W 447mm H 115mm		

heating cables

drain heating cables



1

GEV No.	418614	Ref. No.	R35-0012
description	drain heating cable 35W 220V ø 6mm L 1910mm L1 (unheated) 870mm L2 (heated) 1040mm silicone connection terminal		

connection on both sides (metal braided)



1

GEV No.	417643	Ref. No.	R35-0011
description	drain heater 126W 220V L 7600mm L1 (unheated) 1000mm L2 (heated) 6600mm ø 3.6mm		



1

GEV No.	416334	Ref. No.	R35-0216
description	heating cable 188W 230V L1 (unheated) 2x540mm L2 (heated) 7000mm ø 4mm L 8080mm connection terminal		

miscellaneous



1

GEV No.	418499	Ref. No.	R35-0002
description	heating cable L 7000mm door frame heating 205Ohm/m		

thermostats

refrigeration thermostats

universal with housing



1

GEV No.	390538	Ref. No.	R30-0051
description	thermostat temperature range -35 up to +35°C probe ø6x110mm capillary pipemm PRODIGY		

1 electric components



switches and momentary switches

rocker/momentary rocker switches

30x22mm



1

GEV No.	301000	Ref. No.	R25-0012
description	rocker switch mounting measurements 30x22mm blue 2NO 250V 16A illuminated 0-l connection male faston 6.3mm ambient temperature max. 125/55°C protection IP40		
accessories for	301000		
	GEV No.	301036	Ref. No. —
	protective cover internal size 30x22mm for rocker switch mounting measurementsmm		



1

GEV No.	301003	Ref. No.	R25-0002
description	rocker switch mounting measurements 30x22mm green 2NO 250V 16A illuminated 0-l connection male faston 6.3mm ambient temperature max. 125/55°C protection IP65		
accessories for	301003		
	GEV No.	301036	Ref. No. —
	protective cover internal size 30x22mm for rocker switch mounting measurementsmm		

labelled



1

GEV No.	300125	Ref. No.	R25-0010
description	rocker switch mounting measurements 30x22mm green 2NO 230V 16A 0-l connection male faston 6.3mm ambient temperature max. 125/55°C protection IP65 with cover cap		
accessories for	300125		
	GEV No.	301036	Ref. No. —
	protective cover internal size 30x22mm for rocker switch mounting measurementsmm		

microswitches

with push button

switches with snap-fit



1

GEV No.	346772	Ref. No.	R25-0086
description	microswitch with push button 250V 5A 1CO connection male faston 4.8mm L 24x27mm ambient temperature max. 85°C actuating force: 160g		

magnetic switches

65x20mm



1

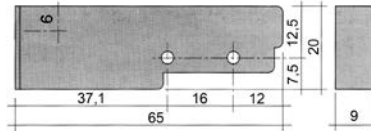

GEV No.	345633	Ref. No.	R25-0043
description	magnetic switch L 65mm W 20mm connection cable		

accessories

magnets

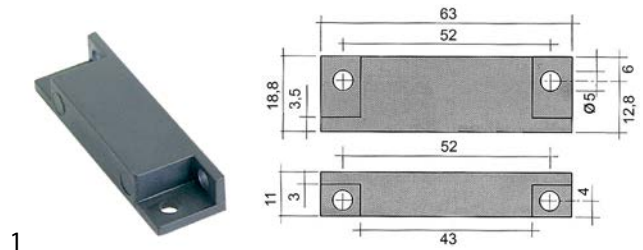

1

GEV No.	345336	Ref. No.	R25-0044
description	magnet \varnothing 4.8mm L 63mm H 11mm W 18.8mm hole distance 51mm M4		

lamps

fluorescent lamps

fluorescent lamps

G13



1

GEV No.	359372	Ref. No.	R50-0003
description	fluorescent lamp socket G13 L 895mm 30W 230V Qty 1 pcs		

accessories

starter holders



1

GEV No.	380466	Ref. No.	R50-0007
description	starter holder		





starter			
			
1			
GEV No.	380467	Ref. No.	R50-0006
description	starter 4-80W		

ballasts			
			
1			
GEV No.	401141	Ref. No.	R35-0023
description	electrical ballast 30W 230V for fluorescent lamps Qty 1 pcs		

fridge lamps

producer-specific fridge lamps

DESMON			
			
1			
GEV No.	700650	Ref. No.	80010300
description	lamp complete		

			
1			
GEV No.	700651	Ref. No.	80010320
description	lamp complete		

			
1			
GEV No.	700652	Ref. No.	80010330
description	lamp wall-mounted version		

relays

power relays

with bracket mounting

			
1			
GEV No.	380687	Ref. No.	R35-0253
description	power relays FINDER 230VAC 30A 2NO connection F6.3 bracket mounting manuf. no. 66.82.8.230.0300		



electronic controllers

DIXELL















refrigeration controllers



built-in version

			
1			
GEV No.	402143	Ref. No.	R35-0375
description	electronic controller DIXELL R35-0375 mounting measurements 71x29mm		

				
1				
GEV No.	378363	Ref. No.	R35-XR06CX	
description	electronic controller DIXELL XR06CX-5R0C1 mounting measurements 71x29mm 230V voltage AC NTC relay outputs 3 NO-20A(8) CO-8A(3) NO-5A(2) NTC NTC DI protection IP54 -40 up to +110°C display 3½ digits			
accessories for	378363			
	GEV No.	381249	Ref. No.	—
	 temperature probe NTC 10kOhm cable PVC probe -40 up to +110°C cable -10 up to 100°C connection 2-wire thread probe ø6x14mm cable length 3m			



			
1			
GEV No.	378000	Ref. No.	R35-0141 R35-XR20CX R35-XR20CX -5N0C1
description	electronic controller DIXELL XR20CX-5N0C1 mounting measurements 71x29mm 230V voltage AC NTC/PTC relay outputs 1 NO-20A(8) NTC/PTC NTC/PTC/DI protection IP54 -50 up to +150°C display 3½ digits		
accessories for	378000		
	GEV No.	378194	Ref. No. —
	temperature probe NTC 10kOhm cable PVC probe -20 up to +80°C cable -10 up to 100°C probe ø7x24.5mm cable length 1.5m without screw connection 2-wire		
	GEV No.	378551	Ref. No. —
	adapter for reducer mounting measurements 71x29mm		
	GEV No.	379052	Ref. No. —
	temperature probe PTC 1kOhm cable silicone probe -50 up to +150°C cable -50 up to +180°C probe ø6x40mm cable length 1.5m without screw connection 2-wire		
	GEV No.	379053	Ref. No. —
	temperature probe PTC 1kOhm cable PVC probe -50 up to +150°C cable -10 up to 100°C probe ø6x30mm cable length 3m without screw connection 2-wire		
	GEV No.	379057	Ref. No. —
	temperature probe NTC 10kOhm cable PVC probe -20 up to +80°C cable -10 up to 100°C probe ø6x25mm cable length 3m 2-wire		
	GEV No.	379064	Ref. No. —
	temperature probe PTC 1kOhm cable silicone probe -50 up to +150°C cable -50 up to +180°C probe ø6x40mm cable length 3m without screw connection 2-wire		
	GEV No.	379142	Ref. No. —
	temperature probe PTC 1kOhm cable PVC probe -50 up to +150°C cable -10 up to 100°C probe ø6x30mm cable length 1.5m without screw connection 2-wire		
	GEV No.	379160	Ref. No. —
	temperature probe NTC 10kOhm cable thermoplastic probe -40 up to +110°C cable -40 up to +110°C probe ø6x14mm cable length 1.5m without screw connection 2-wire		
	GEV No.	379161	Ref. No. Q32-0216 Q32-0578 R35-0227
	temperature probe NTC 10kOhm cable thermoplastic probe -40 up to +110°C cable -40 up to +110°C probe ø6x14mm cable length 3m without screw connection 2-wire		
	GEV No.	379343	Ref. No. —
	temperature probe NTC 10kOhm cable silicone probe -40 up to +110°C cable -50 up to +180°C probe ø6x40mm cable length 3m 2-wire		
	GEV No.	379458	Ref. No. —
	temperature probe NTC 10kOhm cable silicone probe -40 up to +110°C cable -50 up to +180°C probe ø6x40mm cable length 1.5m without screw connection 2-wire		
	GEV No.	379781	Ref. No. —
	temperature probe PTC 1kOhm cable thermoplastic probe -50 up to +150°C cable -40 up to +110°C probe ø6x14mm cable length 1.5m without screw connection 2-wire		
	GEV No.	379782	Ref. No. —
	temperature probe PTC 1kOhm cable thermoplastic probe -50 up to +150°C cable -40 up to +110°C probe ø6x14mm cable length 3m 2-wire resistor 1kOhm		

accessories for	378000		
	GEV No.	402818	Ref. No. —
	programming key 4K for electronic controller DIXELL		
	GEV No.	699260	Ref. No. —
	connection cable L 2m connection coded plug		

			
1			
GEV No.	402038	Ref. No.	R35-0143
description	electronic controller DIXELL XR60C-5N3C1 mounting measurements 71x29mm 230V voltage AC NTC		











			
1			
GEV No.	402144	Ref. No.	R35-XR60CX XR60C-5N1C0
description	electronic controller DIXELL XR60CX-5N0C1 mounting measurements 71x29mm 230V voltage AC NTC/PTC relay outputs 3 NO-20A(8) CO-8A(3) NO-5A(2) NTC/PTC NTC/PTC DI -50 up to +150°C display 3½ digits		
accessories for	402144		
	GEV No.	378194	Ref. No. —
	temperature probe NTC 10kOhm cable PVC probe -20 up to +80°C cable -10 up to 100°C probe ø7x24.5mm cable length 1.5m without screw connection 2-wire		
	GEV No.	378551	Ref. No. —
	adapter for reducer mounting measurements 71x29mm		
	GEV No.	379052	Ref. No. —
	temperature probe PTC 1kOhm cable silicone probe -50 up to +150°C cable -50 up to +180°C probe ø6x40mm cable length 1.5m without screw connection 2-wire		
	GEV No.	379053	Ref. No. —
	temperature probe PTC 1kOhm cable PVC probe -50 up to +150°C cable -10 up to 100°C probe ø6x30mm cable length 3m without screw connection 2-wire		
	GEV No.	379057	Ref. No. —
	temperature probe NTC 10kOhm cable PVC probe -20 up to +80°C cable -10 up to 100°C probe ø6x25mm cable length 3m 2-wire		
	GEV No.	379064	Ref. No. —
	temperature probe PTC 1kOhm cable silicone probe -50 up to +150°C cable -50 up to +180°C probe ø6x40mm cable length 3m without screw connection 2-wire		
	GEV No.	379160	Ref. No. —
	temperature probe NTC 10kOhm cable thermoplastic probe -40 up to +110°C cable -40 up to +110°C probe ø6x14mm cable length 1.5m without screw connection 2-wire		

Table continues overleaf

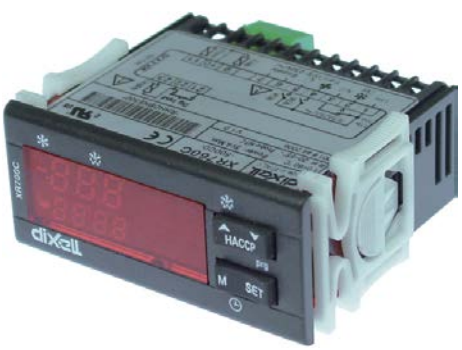

accessories for 402144				
GEV No.	379161	Ref. No.	Q32-0216 Q32-0578 R35-0227	
temperature probe NTC 10kOhm cable thermoplastic probe -40 up to +110°C cable -40 up to +110°C probe ø6x14mm cable length 3m without screw connection 2-wire				
GEV No.	379343	Ref. No.	—	
temperature probe NTC 10kOhm cable silicone probe -40 up to +110°C cable -50 up to +180°C probe ø6x40mm cable length 3m 2-wire				
GEV No.	379458	Ref. No.	—	
temperature probe NTC 10kOhm cable silicone probe -40 up to +110°C cable -50 up to +180°C probe ø6x40mm cable length 1.5m without screw connection 2-wire				
GEV No.	379782	Ref. No.	—	
temperature probe PTC 1kOhm cable thermoplastic probe -50 up to +150°C cable -40 up to +110°C probe ø6x14mm cable length 3m 2-wire resistor 1kOhm				
GEV No.	402818	Ref. No.	—	
 programming key 4K for electronic controller DIXELL				

				
1				
GEV No.	378020	Ref. No.	R35-0193	
description	electronic controller DIXELL XR760C-500C0 mounting measurements 71x29mm defr. funct. no			

				
1				
GEV No.	402036	Ref. No.	R35-0144	
description	electronic controller DIXELL XW260L-5N0C0 mounting measurements 150x30mm built-in depth 65.5mm 230V voltage AC NTC relay outputs 4 NO-20A(8) NO-8A(3) NO-8A(3) NO-16A(5) NTC NTC DI DI DI DI yes yes -50 up to +150°C display 3½ digits			
accessories for 402036				
GEV No.	378194	Ref. No.	—	
temperature probe NTC 10kOhm cable PVC probe -20 up to +80°C cable -10 up to 100°C probe ø7x24.5mm cable length 1.5m without screw connection 2-wire				
GEV No.	379057	Ref. No.	—	
temperature probe NTC 10kOhm cable PVC probe -20 up to +80°C cable -10 up to 100°C probe ø6x25mm cable length 3m 2-wire				
GEV No.	379160	Ref. No.	—	
temperature probe NTC 10kOhm cable thermoplastic probe -40 up to +110°C cable -40 up to +110°C probe ø6x14mm cable length 1.5m without screw connection 2-wire				

accessories for 402036				
GEV No.	379161	Ref. No.	Q32-0216 Q32-0578 R35-0227	
temperature probe NTC 10kOhm cable thermoplastic probe -40 up to +110°C cable -40 up to +110°C probe ø6x14mm cable length 3m without screw connection 2-wire				
GEV No.	379343	Ref. No.	—	
temperature probe NTC 10kOhm cable silicone probe -40 up to +110°C cable -50 up to +180°C probe ø6x40mm cable length 3m 2-wire				
GEV No.	379458	Ref. No.	—	
temperature probe NTC 10kOhm cable silicone probe -40 up to +110°C cable -50 up to +180°C probe ø6x40mm cable length 1.5m without screw connection 2-wire				
GEV No.	402818	Ref. No.	—	
 programming key 4K for electronic controller DIXELL				

				
1				
GEV No.	378027	Ref. No.	R35-0206	
description	electronic controller DIXELL XW760L-5N0C3 mounting measurements 150x30mm			
accessories for 378027				
GEV No.	378194	Ref. No.	—	
temperature probe NTC 10kOhm cable PVC probe -20 up to +80°C cable -10 up to 100°C probe ø7x24.5mm cable length 1.5m without screw connection 2-wire				
GEV No.	379057	Ref. No.	—	
temperature probe NTC 10kOhm cable PVC probe -20 up to +80°C cable -10 up to 100°C probe ø6x25mm cable length 3m 2-wire				
GEV No.	379160	Ref. No.	—	
temperature probe NTC 10kOhm cable thermoplastic probe -40 up to +110°C cable -40 up to +110°C probe ø6x14mm cable length 1.5m without screw connection 2-wire				
GEV No.	379161	Ref. No.	Q32-0216 Q32-0578 R35-0227	
temperature probe NTC 10kOhm cable thermoplastic probe -40 up to +110°C cable -40 up to +110°C probe ø6x14mm cable length 3m without screw connection 2-wire				
GEV No.	379343	Ref. No.	—	
temperature probe NTC 10kOhm cable silicone probe -40 up to +110°C cable -50 up to +180°C probe ø6x40mm cable length 3m 2-wire				
GEV No.	379458	Ref. No.	—	
temperature probe NTC 10kOhm cable silicone probe -40 up to +110°C cable -50 up to +180°C probe ø6x40mm cable length 1.5m without screw connection 2-wire				









ELIWELL

refrigeration controllers

built-in version



1	GEV No.	378285	Ref. No.	EISB7-28 R35-EWP0974A-230V
description	electronic controller ELIWELL type EWPlus 974 mounting measurements 71x29mm 230V voltage AC NTC/PTC/Pt1000 relay outputs 2 NO-12A CO-8A NO-5A NTC/PTC/Pt1000 NTC/PTC/Pt1000 front measurements 74x32mm built-in depth 59mm yes -50 up to +110°C display 3½ digits			

accessories for	378285			
	GEV No.	378184	Ref. No.	—
	electronic controller LAE type LCD32Q4E-C mounting measurements 149x30mm 230V voltage AC NTC relay outputs 4 NO-20A(6) NO-12A(4) NO-8A(3) CO-8A(3) NTC NTC DI DI front measurements 169x38mm built-in depth 78mm protection IP55 yes yes -30 up to +30°C display 3 digits			
	GEV No.	378194	Ref. No.	—
	temperature probe NTC 10kOhm cable PVC probe -20 up to +80°C cable -10 up to 100°C probe ø7x24.5mm cable length 1.5m without screw connection 2-wire			
	GEV No.	379057	Ref. No.	—
	temperature probe NTC 10kOhm cable PVC probe -20 up to +80°C cable -10 up to 100°C probe ø6x25mm cable length 3m 2-wire			
	GEV No.	379160	Ref. No.	—
	temperature probe NTC 10kOhm cable thermoplastic probe -40 up to +110°C cable -40 up to +110°C probe ø6x14mm cable length 1.5m without screw connection 2-wire			
	GEV No.	379161	Ref. No.	Q32-0216 Q32-0578 R35-0227
	temperature probe NTC 10kOhm cable thermoplastic probe -40 up to +110°C cable -40 up to +110°C probe ø6x14mm cable length 3m without screw connection 2-wire			
	GEV No.	379343	Ref. No.	—
	temperature probe NTC 10kOhm cable silicone probe -40 up to +110°C cable -50 up to +180°C probe ø6x40mm cable length 3m 2-wire			
	GEV No.	379458	Ref. No.	—
	temperature probe NTC 10kOhm cable silicone probe -40 up to +110°C cable -50 up to +180°C probe ø6x40mm cable length 1.5m without screw connection 2-wire			



1	GEV No.	378021	Ref. No.	R35-0155 R35-0365
description	electronic controller ELIWELL type ID961 mounting measurements 71x29mm NTC/PTC -55 up to +150°C display 3½ digits			



1	GEV No.	378022	Ref. No.	R35-0156 R35-0370
description	electronic controller ELIWELL type ID974 mounting measurements 71x29mm 230V voltage AC NTC/PTC front measurements 33x75mm protection IP65 -50 up to +150°C display 3½ digits			

miscellaneous

refrigeration controllers



1	GEV No.	378023	Ref. No.	80110040
description	electronic controller kit DESMON			



1	GEV No.	378024	Ref. No.	80210040
description	electronic controller kit DESMON			



1	GEV No.	378025	Ref. No.	80080040
description	electronic controller kit DESMON			



1	GEV No.	378026	Ref. No.	80280040
description	electronic controller kit DESMON			



1	GEV No.	378028	Ref. No.	81010200
description	electronic controller kit DESMON type gold			



1	GEV No.	378029	Ref. No.	81000200E 81080200
description	electronic controller kit DESMON type gold			



probes

universal probes

temperature probes



GEV No.	379161	Ref. No.	Q32-0216 Q32-0578 R35-0227
description	temperature probe NTC 10kOhm cable thermoplastic probe -40 up to +110°C cable -40 up to +110°C probe ø6x14mm cable length 3m without screw connection 2-wire		

electronics

PCBs



GEV No.	361985	Ref. No.	80100040 80100040E 80190040
description	PCB kit DESMON edition gold		

keypads

front foils



GEV No.	511928	Ref. No.	B99-0138
description	keypad foil silver L 290mm W 56mm buttons 6		

solenoid valves

solenoid valves (refrigeration)





CASTEL

valve bodies

STANDARD series

suitable for refrigerants R22, R134a, R404A, R407C, R410A, R507



GEV No.	370382	Ref. No.	R30-0036
description	solenoid valve body NC type 1028/M10S p max 45bar connection 10mm soldering connection DN 3mm -35 up to +105°C L 125mm refrigeration straight CASTEL		
accessories for	370382		
	GEV No.	371084	Ref. No. —
	solenoid coil CASTEL 230VAC 8VA 50/60Hz connection cable 1000mm type CM2		
	GEV No.	371090	Ref. No. —
	power socket plug type DIN 43650A screw		
	GEV No.	371301	Ref. No. —
	solenoid coil CASTEL 110VAC 8VA 50/60Hz seat ø 11.5mm connection DIN 43650A type HF2		
	GEV No.	371314	Ref. No. —
	solenoid coil CASTEL 240VAC 8VA 50/60Hz seat ø 11.5mm		
	GEV No.	371321	Ref. No. —
	solenoid coil CASTEL 12/24VAC 50/60Hz seat ø 11.5mm connection DIN 43650A type HF2		

CEME

valves

with pipe clamp



GEV No.	370380	Ref. No.	R30-0031 R30-0035
description	solenoid valve straight CEME type 6806 230V p max 25bar connection 6mm soldering connection -45 up to +125°C refrigeration 50Hz		



cooling aggregates

GEV No.	379304***	Ref. No.	123456
description			
For models:			

GEV No.	379304***	Ref. No.	123456
description			
For models:			

GEV No.	379304***	Ref. No.	123456
description			
For models:			

GEV No.	379304***	Ref. No.	123456
description			
For models:			

GEV No.	379304***	Ref. No.	123456
description			
For models:			

GEV No.	379304***	Ref. No.	123456
description			
For models:			

GEV No.	379304***	Ref. No.	123456
description			
For models:			

GEV No.	379304***	Ref. No.	123456
description			
For models:			

GEV No.	379304***	Ref. No.	123456
description			
For models:			

GEV No.	379304***	Ref. No.	123456
description			
For models:			

GEV No.	379304***	Ref. No.	123456
description			
For models:			

GEV No.	379304***	Ref. No.	123456
description			
For models:			

compressors

ACC/ZEL

R134A

HMBP monophase

High/Medium evaporation temperature above -20/-15 °C



GEV No.	605008	Ref. No.	Q32-0431
description	compressor coolant R134a type GL80TB 220-240V 50Hz HMBP fully hermetic 9.5kg 1/5HP power input 554W cylinder capacity 7.6cm ³ CSIR H 175.5mm 165W 215W 290W 390W 500W 615W 727W 840W test method ASHRAE ambient temperature max. 43°C		



GEV No.	605009	Ref. No.	Q32-0432
description	compressor coolant R134a type GL90TB 220-240V 50Hz HMBP fully hermetic 10.8kg 1/4HP power input 293W cylinder capacity 8.8cm ³ CSIR H 175.5mm 143W 194W 259W 339W 432W 539W 661W 796W test method ASHRAE		



R404a/R507

LBP monophase

Lower evaporation temperature below -20°C



1

GEV No.	605127	Ref. No.	EISB7-1 Q32-0701 Q32-0708
description	compressor coolant R404a/R507 type MX18FB 220-240V 50Hz LBP 17.3kg 5/8HP cylinder capacity 18.4cm ³ CSR H 230mm 575W 750W 985W 1219W 1498WWWWWW test method ASHRAE ambient temperature max. 43°C		

HMBP monophase

High/Medium evaporation temperature above -20/-15 °C



1

GEV No.	605014	Ref. No.	Q32-0434
description	compressor coolant R404a/R507 type ML80TB 220-240V 50Hz HMBP fully hermetic 11.4kg 3/8HP cylinder capacity 7.57cm ³ CSIR H 175.5mmW 261W 346W 446W 561W 691W 835W 993W 1167W test method ASHRAE ambient temperature max. 43°C		

CUBIGEL

R404a/R507

LBP monophase

Lower evaporation temperature below -20°C



1

GEV No.	605180	Ref. No.	Q32-0705
description	compressor coolant R404a/R507 type MX23FB 220-240V 50Hz LBP 17.5kg 1HP power input 7/8W cylinder capacity 23.2cm ³ CSR H 221mm 749W 982W 1246W 1541W 1868WWWWWW		



1

GEV No.	605075	Ref. No.	Q32-0706
description	compressor coolant R404a/R507a type MX21FB_A 220-240V 50Hz LBP 16.5kg 3/4HP cylinder capacity 20.72cm ³ CSR H 220mm 575W 655W 742W 836W 938WWWWWW test method ASHRAE		

HMBP monophase

High/Medium evaporation temperature above -20/-15 °C



1

GEV No.	605013	Ref. No.	Q32-0438 Q32-0652
description	compressor coolant R404a/R507 type ML60TB 220-240V 50Hz HMBP fully hermetic 10.1kg 1/4HP power input 647W cylinder capacity 5.68cm ³ CSIR H 175.5mmW 244W 319W 407W 511W 628W 760W 906W 1067W test method ASHRAE		



1

GEV No.	605029	Ref. No.	Q32-0439 Q32-0498
description	compressor coolant R404a/R507 type MP12RB 220-240V 50Hz HMBP fully hermetic 13.5kg 1/2HP cylinder capacity 12cm ³ CSIR H 203.6mmW 561W 734W 933W 1157W 1407W 1681W 1982WW test method ASHRAE ambient temperature max. 43°C		



electric components

EMBRACO / ASPERA

R404a/R507



1

GEV No.	605130	Ref. No.	Q32-0269
description	compressor coolant R404a/R507 type EMT6144GK 220-240V 50Hz HMBP fully hermetic 8.1kg 1/6HP cylinder capacity 3.97cm ³ CSIR H 175mmW 246W 307W 377W 459W 552W 656W 774W at +7,2°C 637W		

L'UNITE HERMETIQUE / TECUMSEH

R404A

HMBP monophase

High/Medium evaporation temperature above -20/-15 °C



1

GEV No.	605025	Ref. No.	Q32-0703
description	compressor coolant R404A type AE4430Z-FZ 220-240V 50Hz HMBP fully hermetic 10.2kg 1/4HP power input 427W cylinder capacity 5.7cm ³ CSIR H 186mmWW 258W 346W 441W 550W 682W 794W test method EN 12900 908W		
spare parts for	605025		
	GEV No.	380061	Ref. No. —
	start relay MTRP0027-31 120/240V voltage AC 8A 1NO		



1

GEV No.	605158	Ref. No.	Q32-0747
description	compressor coolant R404A type AE4470Z 220-240V 50Hz HMBP fully hermetic 13.7kg 1/2HP cylinder capacity 12cm ³ CSR H 207mmW 670W 843W 1035W 1251W 1495W 1773W 2088W 2447W		

evaporation and condensing trays

evaporation trays heated



1

GEV No.	750212	Ref. No.	89020710
description	condensing tray with heating cable for evaporator L 875mm W 447mm H 115mm		

condensing trays heated

producer-specific



1

GEV No.	695271	Ref. No.	Q32-0196 Q32-0196L
description	condensing tray heated L 410mm W 300mm H 80mm 230V 230W		
For models:	ID140		

unheated condensing trays



1

GEV No.	750214	Ref. No.	89010180
description	condensing tray unheated L 465mm W 360mm		
accessories for	750214		
	GEV No.	417643	Ref. No. R35-0011
	drain heater 126W 220V L 7600mm L1 (unheated) 1000mm L2 (heated) 6600mm ø 3.6mm		





fans

axial fans

import



1

GEV No.	601080 ¹	Ref. No.	R05-0006
description	axial fan L 119mm W 119mm H 38mm 230VAC 50/60Hz 23/20W bearing ball bearing connection male faston 2.8mm metal ADDA fan wheel ø 110mm temp.-resist. 70°C		
For models:	LUX 3C4		
accessories for	601080		
	GEV No.	550898	Ref. No. —
	connecting cable cable length 2000mm connection F 2.8 connection distance 7.9mm for axial flow fan		
	GEV No.	692519	Ref. No. —
	guard L 120mm W 120mm plastic		

¹with ball bearings

refrigeration fans

refrigeration motors universal

ELCO

N series - standard



1

GEV No.	601359	Ref. No.	P36-0012 Q32-0132
description	fan motor 18W 230V 50/60Hz bearing slide bearing W 83mm connection 3-wire cable length 1000mm 1300/1550rpm 3 mounting options VNT18-30/150		
spare parts for	601359		
	GEV No.	601413	Ref. No. —
	fixing plate suitable for fanwheel ED ø 32mm shaft ø 7 mounting distance 26mm		



1

GEV No.	601729	Ref. No.	R05-0005
description	fan motor ELCO 10W 230V 50/60Hz L2 54mm L3 79mm cable length 1300mm VN10-20/229		



1

GEV No.	601442	Ref. No.	R35-0026
description	fan motor ELCO 10W 230V 50-60Hz bearing slide bearing L1 45mm L3 83mm W 83mm cable length 1800mm 1300/1550rpm 3 mounting options VN10-20/507 triple		
spare parts for	601442		
	GEV No.	601413	Ref. No. —
	fixing plate suitable for fanwheel ED ø 32mm shaft ø 7 mounting distance 26mm		



1

GEV No.	601358	Ref. No.	R05-0194
description	fan motor ELCO 12W 230V 50Hz W 83mm VNT12-20/334		



RE series



GEV No.	601608	Ref. No.	Q32-0590
description	fan motor 18W 230/240V 50/60Hz W 90mm cable length 1000mm 2600rpm ELCO R18-25/010 3 mounting options bearing slide bearing H 110mm L 90mm		
spare parts for	601608		
	GEV No.	601413	Ref. No. —
fixing plate suitable for fanwheel ED ϕ 32mm shaft ϕ 7 mounting distance 26mm			

IMPORT

multi fit fan motors



GEV No.	601022	Ref. No.	R05-0100
description	fan motor 10W 230V 50-60Hz L1 44mm L2 54mm L3 85mm W 84mm cable length 500mm 1300rpm YZF10-20-18/26 5 mounting options bearing slide bearing		

accessories

fan wheels

aluminium

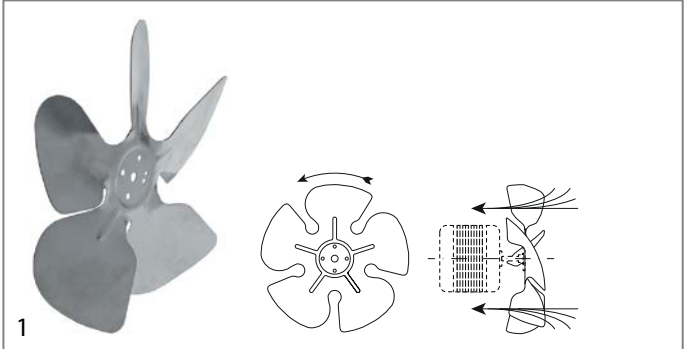

GEV No.	601070	Ref. No.	P36-0027 Q32-0591
description	fan wheel sucking ϕ 200mm fan wheel mounting 25.4mm blade angle 28° W 38mm aluminium		

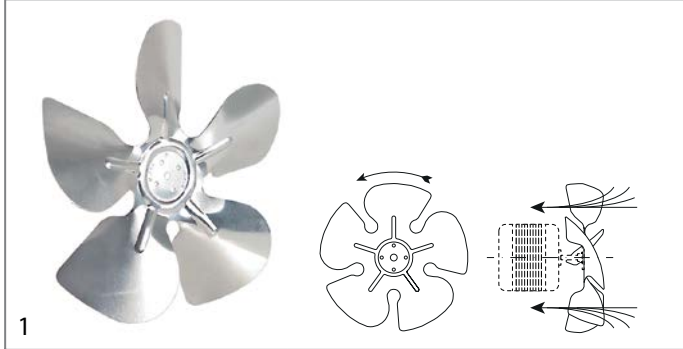

GEV No.	601284	Ref. No.	P36-0028
description	fan wheel sucking ϕ 254mm fan wheel mounting 25.4mm blade angle 28° W 42mm aluminium		

cooling motors (various)

accessories for cooling fan





GEV No.	601377	Ref. No.	Q32-0123
description	guard		

cold air circulating fans

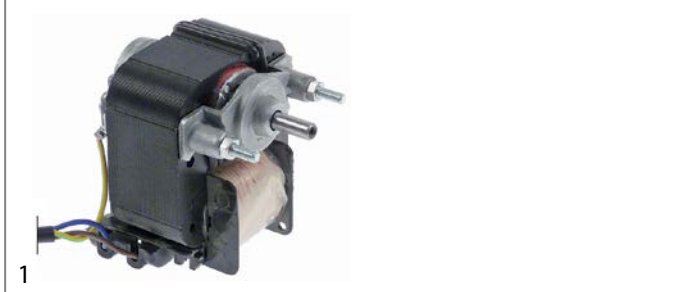
cold air circulating fans





GEV No.	750398	Ref. No.	R35-0019 R35-0177
description	fan motor 230/240V 50/60Hz 35W shaft ϕ 6mm shaft L 14mm W 62mm H 73mm		
accessories for	750398		
	GEV No.	601413	Ref. No. —
fixing plate suitable for fanwheel ED ϕ 32mm shaft ϕ 7 mounting distance 26mm			
	GEV No.	602184	Ref. No. —
fixing plate suitable for fanwheel ED ϕ 33mm shaft ϕ 6 mounting distance 17mm			



cold air circulating fans (other)



GEV No.	601375	Ref. No.	R05-0139 R05-0139 PLASET
description	fan motor 230V 50/60Hz 10W W 84mm H 87mm D 95mm shaft L 25mm shaft ø 8mm PLASET type 20182 cable length 1000mm 1350rpm		
accessories for	601375		
	GEV No.	601282	Ref. No. —
	fan wheel sucking ø 200mm fan wheel mounting 25.4mm blade angle 34° W 44mm aluminium		
	GEV No.	601570	Ref. No. —
	fan wheel blowing ø 200mm fan wheel mounting 25.4mm blade angle 28° W 37mm aluminium		

cross flow fans

COPREL

with standard coil



GEV No.	601248	Ref. No.	Q32-45180
description	cross flow fan TFL 45 roller ø 45mm roller length 180mm laminated core thickness 20mm motor position left 230V/50-60Hz 26W universal bearing silicone connection male faston 6.3mm airflow 123m ³ /h -30 up to +100°C 230V 50Hz		

condensators & interference suppression filters

filters

interference suppression filters



GEV No.	365053	Ref. No.	S06-0036 S06-0038
description	interference suppression filter capacity 0.1µF(X1)+2x5000pF(Y2) 1.5MOhm		

fuses

fine fuses



GEV No.	358666	Ref. No.	R35-0081
description	fine fuse size ø5x20mm 0.315A fast-acting rated 250V Qty 10 pcs		

electric accessories

terminals

terminal blocks with fuse holder



GEV No.	358389	Ref. No.	R25-0054
description	lustre terminal 0-pole max. 10A max 250V suitable fuse ø5x20mm cross section 2.5mm ² with fuse holder		

equipment-specific units

for fridges

housing and bezels

covers



GEV No.	700905	Ref. No.	H99-1867
description	cover left plastic L 75mm W 50mm H 10mm		



GEV No.	700903	Ref. No.	H99-1868
description	cover right plastic L 75mm W 50mm H 10mm		

drawers

accessories



1			
GEV No.	750246	Ref. No.	4181432
description	bottom plate for fish tank L 415mm W 370mm H 15mm stainless steel		

miscellaneous



1			
GEV No.	692180	Ref. No.	Q32-0222
description	cover with sump for evaporator L 388mm W 353mm H 114mm plastic for fridge		

for refrigerated counters

doors



1			
GEV No.	695608	Ref. No.	6101500
description	door suitable for refrigerated counter		
accessories for	695608		
	GEV No.	900595	Ref. No. DT232-5.7.1 H25-0030
	refrigeration gasket profile 9010 W 415mm L 625mm plug size		

for dishwashers

mechanics for flight type dishwashers



1			
GEV No.	511996	Ref. No.	927083
description	tappet for dishwasher right L 62mm W 52mm H 19mm hole ø 12mm		

handles and hand wheels

bracket handles



1			
GEV No.	690450	Ref. No.	N/A
description	pull handle L 275mm H 43mm mounting distance 227mm		

recessed handles



1			
GEV No.	695599	Ref. No.	P22-0057
description	handle L 220mm W 107mm H 28mm mounting measurements 204x94mm		

locks

locking devices

producer-specific

DESMON



1			
GEV No.	690976	Ref. No.	80010310
description	key cylinder with slide latch ø 23mm thread M19x1 mounting measurements 16.5x19mm hub 38-45mm shaft ø 11mm thread L 16mm HD/ID		



walk-in fridge catches

CONI TECHNIC



1

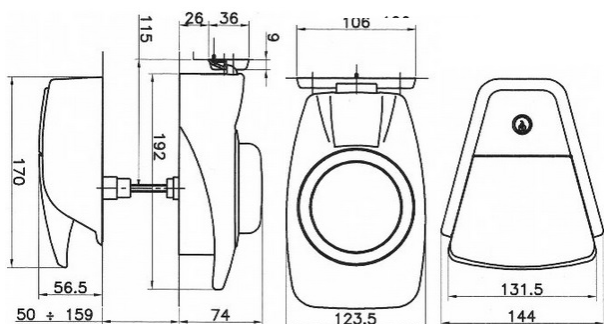

GEV No.	690993	Ref. No.	P28-0161 P28-0162
description	walk-in fridge catch type ActivA door thickness 50-140mm H 192mm W 123.5mm complete with door catch		

miscellaneous



1

GEV No.	700665	Ref. No.	8922500
description	catch		



Image not available

1

GEV No.	700654	Ref. No.	89010200
description	door catch kit		

hinges

spring assisted hinges

producer-specific

DESMON



1

GEV No.	700638	Ref. No.	89000040
description	spring assisted hinge		



1

GEV No.	700646	Ref. No.	89000100
description	spring assisted hinge complete		



1

GEV No.	700641	Ref. No.	89060300 89060310 89060320 89060330
description	spring assisted hinge complete stainless steel		



1

GEV No.	700635	Ref. No.	89100040
description	spring assisted hinge kit		



1

GEV No.	700607	Ref. No.	89110040
description	spring assisted hinge old edition until 2007		



1

GEV No.	701010	Ref. No.	89010020
description	spring assisted hinge kit mounting pos. left/right 400 LT TN-BASIC		



1

GEV No.	701011	Ref. No.	08001000 84189990 P28-0265 P28-0847
description	spring assisted hinge with hinge camp L 74mm W 24mm shaft length 18mm mounting distance 25mm mounting measurements 22x22x100mm		



1

GEV No.	700645	Ref. No.	89100100
description	spring assisted hinge left		

GIGA



1

GEV No.	701011	Ref. No.	08001000 84189990 P28-0265 P28-0847
description	spring assisted hinge with hinge camp L 74mm W 24mm shaft length 18mm mounting distance 25mm mounting measurements 22x22x100mm		



1

GEV No.	700620	Ref. No.	89000030
description	spring assisted hinge new edition since 2007		

door bearing





1

GEV No.	700606	Ref. No.	H49-0003
description	bush for hinge		





 <p>1</p>			
GEV No.	700605	Ref. No.	89000060
description	door hinge kit		

 <p>1</p>			
GEV No.	700636	Ref. No.	8301160
description	hinge bearing mounting pos. kit with bolt		

 <p>1</p>			
GEV No.	700647	Ref. No.	89000070
description	hinge bearing mounting pos. kit with bolt		
For models:	TSS3		

 <p>1</p>			
GEV No.	700649	Ref. No.	89000620
description	hinge bearing mounting pos. right with bolt		

 <p>1</p>			
GEV No.	700644	Ref. No.	89000310
description	hinge bearing mounting pos. upper left with bolt		

 <p>1</p>			
GEV No.	700648	Ref. No.	89000610
description	hinge bearing mounting pos. upper left with bolt		

 <p>1</p>			
GEV No.	700643	Ref. No.	89000300
description	hinge bearing mounting pos. upper right with bolt		

 <p>1</p>			
GEV No.	692760	Ref. No.	P99-0031
description	hinge camp L 185mm W 50mm H 10mm mounting pos. lower for DESMON		

equipment feet and end caps

equipment feet

with screw mounting

 <p>1</p>			
GEV No.	701057	Ref. No.	89010400
description	equipment feet kit tube ø 65mm thread M10 thread L 10mm H 115-180mm plastic size 2" Qty 4 pcs		

 <p>1</p>			
GEV No.	701064	Ref. No.	89010420
description	equipment foot tube ø 2"mm thread M10 thread L 10mm H 120-180mm plastic size 2" Qty 6 pcs		

 <p>1</p>			
GEV No.	701058	Ref. No.	89010440
description	equipment foot tube ø 2"mm thread M10 thread L 24mm H 120-180mm stainless steel size 2" Qty 4 pcs		





			
1			
GEV No.	700621	Ref. No.	89010410
description	equipment foot tube ø 80mm thread M10 H 115-180mm plastic Qty 5 pcs		

with fixing plate

			
1			
GEV No.	701059	Ref. No.	89020400
description	equipment foot		

			
1			
GEV No.	701060	Ref. No.	89020410
description	equipment foot		

			
1			
GEV No.	701061	Ref. No.	89030400
description	equipment foot		

			
1			
GEV No.	701062	Ref. No.	89040410
description	equipment foot		

			
1			
GEV No.	701066	Ref. No.	89040400
description	equipment foot		

			
1			
GEV No.	701063	Ref. No.	89030040
description	equipment foot plate size 82x100mm H 120-180mm SS size 2" Qty 8 pcs		

			
1			
GEV No.	701089	Ref. No.	89020040 Q32-0007
description	equipment foot tube ø 64mm plate size 85x100mm hole distance 55x75mm H 120-180mm SS size 2" Qty 1 pcs		

screw-in feet

			
1			
GEV No.	701065	Ref. No.	89010430
description	equipment feet kit thread M10 thread L 36mm ø 48mm H 17mm		

TENTE

with fixing plate

chrome-plated steel

			
1			
GEV No.	701084	Ref. No.	P80-3470
description	swivel castor ø 125mm plate fixing housing chrome-plated steel plate size 105x85mm hole distance 77x66mm capacity 100kg bearing slide bearing wheel body polypropylene tread TPE tyres H 155mm wheel width 32mm Qty 1 pcs		



miscellaneous

with fixing plate

ø125mm



1

GEV No.	701086	Ref. No.	N/A
description	fixed castor ø 125mm plates fixing 102x83mm		



1

GEV No.	701085	Ref. No.	P80-3477 siehe Bemerkung
description	swivel castor with brake ø 125mm plates fixing 102x83mm hole distance 78x60mm tread 32 H 155mm stainless steel		

diverse sets



1

GEV No.	701067	Ref. No.	89010340
description	castor set		

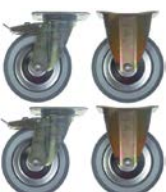

1

GEV No.	701070	Ref. No.	80010350
description	castor set		



1

GEV No.	701068	Ref. No.	81030330
description	castor set ø 125mm plates fixing 102x83mm housing stainless steel		



1

GEV No.	701069	Ref. No.	89010350
description	castor set ø 125mm plates fixing 102x83mm housing zinc-plated sheet steel Qty 5 pcs		



Image not available

1

GEV No.	701078	Ref. No.	81010080
description	swivel castor set		



1

GEV No.	701073	Ref. No.	81020320
description	swivel castor set ø 125mm plate fixing housing zinc-coated steel plate size 102x83mm bearing ball bearing wheel body polypropylene tread TPE tyres wheel width 32mm Qty 4 pcs		



1

GEV No.	701076	Ref. No.	81020300
description	swivel castor set ø 125mm plate fixing housing zinc-coated steel plate size 102x83mm bearing ball bearing wheel body polypropylene tread TPE tyres wheel width 32mm Qty 4 pcs		



1

GEV No.	701071	Ref. No.	81030300
description	swivel castor set ø 125mm plate fixing housing zinc-coated steel plate size 102x83mm bearing ball bearing wheel body polypropylene tread TPE tyres wheel width 32mm Qty 5 pcs		



1

GEV No.	701074	Ref. No.	81030320
description	swivel castor set ø 125mm plate fixing housing zinc-coated steel plate size 102x83mm bearing ball bearing wheel body polypropylene tread TPE tyres wheel width 32mm Qty 5 pcs		



GEV No.	701075	Ref. No.	81010330
description	swivel castor set ø 125mm plate fixing housing zinc-coated steel plate size 102x83mm bearing ball bearing wheel body polypropylene tread TPE tyres wheel width 32mm Qty 6 pcs		





GEV No.	701077	Ref. No.	81040300
description	swivel castor set ø 125mm plate fixing housing zinc-coated steel plate size 102x83mm bearing ball bearing wheel body polypropylene tread TPE tyres wheel width 32mm Qty 6 pcs		



GEV No.	701072	Ref. No.	89010360
description	swivel castor set ø 125mm plate fixing housing zinc-coated steel plate size 102x83mm bearing ball bearing wheel body polypropylene tread TPE tyres wheel width 32mm Qty 8 pcs		



GEV No.	970125	Ref. No.	Q32-0022	
description	grate W 325mm D 530mm GN 1/1 plastic-coated steel crossing wires 1 white suitable for refrigerator			
For models:	LUX 3C4			
accessories for	970125			
	GEV No.	690330	Ref. No.	—
	rack L 1000mm W 22mm H 4mm aperture 3x8mm hole distance 12.5mm stainless steel			
	GEV No.	694700	Ref. No.	—
	shelf support L 31/28mm W 22mm H 18mm SS Qty 12 pcs			
	GEV No.	694701	Ref. No.	—
	shelf support L 31/28mm W 22mm H 17mm SS with hook Qty 12 pcs			



shelves and shelf rails

grates

universal

without upstand



GEV No.	970122	Ref. No.	Q32-0022/I	
description	grate W 325mm D 530mm GN 1/1 H 8mm stainless steel wire gauge frame 7mm lengthwise wires gauge 4mm crossing wires 1			
accessories for	970122			
	GEV No.	690330	Ref. No.	—
	rack L 1000mm W 22mm H 4mm aperture 3x8mm hole distance 12.5mm stainless steel			
	GEV No.	694700	Ref. No.	—
	shelf support L 31/28mm W 22mm H 18mm SS Qty 12 pcs			
	GEV No.	694701	Ref. No.	—
	shelf support L 31/28mm W 22mm H 17mm SS with hook Qty 12 pcs			



GEV No.	970529	Ref. No.	Q32-6040
description	grate W 400mm D 600mm plastic-coated steel suitable for refrigerator		







GEV No.	970530	Ref. No.	Q32-6040/I
description	grate W 400mm D 600mm SS crossing wires 2 suitable for refrigerator		





with upstand





GEV No.	970471	Ref. No.	Q32-0326
description	grate W 485mm D 460mm plastic-coated steel with hinge camp crossing wires 2 suitable for refrigerator for devices with Inox guide rails		





 <p>1</p>			
GEV No.	970473	Ref. No.	Q32-0181 Q32-0182
description	grate W 530mm D 550mm plastic-coated steel with hinge camp wire gauge frame 9mm lengthwise wires gauge 5mm crossing wires 2 suitable for refrigerator with hinge camp		
accessories for	970473		
	GEV No.	690330	Ref. No. —
	rack L 1000mm W 22mm H 4mm aperture 3x8mm hole distance 12.5mm stainless steel		
	GEV No.	694700	Ref. No. —
	shelf support L 31/28mm W 22mm H 18mm SS Qty 12 pcs		
	GEV No.	694701	Ref. No. —
	shelf support L 31/28mm W 22mm H 17mm SS with hook Qty 12 pcs		

 <p>1</p>			
GEV No.	970527	Ref. No.	Q32-0300
description	grate W 530mm D 650mm GN 2/1 chrome-plated steel with hinge camp crossing wires 2 suitable for refrigerator		
accessories for	970527		
	GEV No.	690330	Ref. No. —
	rack L 1000mm W 22mm H 4mm aperture 3x8mm hole distance 12.5mm stainless steel		
	GEV No.	694700	Ref. No. —
	shelf support L 31/28mm W 22mm H 18mm SS Qty 12 pcs		
	GEV No.	694701	Ref. No. —
	shelf support L 31/28mm W 22mm H 17mm SS with hook Qty 12 pcs		

 <p>1</p>			
GEV No.	970492	Ref. No.	Q32-0002
description	grate W 650mm D 530mm GN 2/1 plastic-coated steel with hinge camp for fridge crossing wires 2 grey		
For models:	HD140A, HD70A		
accessories for	970492		
	GEV No.	690991	Ref. No. 400020 4080584 4180014
	guide U-shape L 630mm W 15mm H 19mm mounting pos. left/right		

 <p>1</p>			
GEV No.	970528	Ref. No.	Q32-0002/1
description	grate W 650mm D 530mm GN 2/1 stainless steel with hinge camp crossing wires 2 suitable for refrigerator		

producer-specific			
 <p>1</p>			
GEV No.	970531	Ref. No.	Q32-7100
description	grate W 100mm D 565mm plastic-coated steel suitable for refrigerator		

 <p>1</p>			
GEV No.	970532	Ref. No.	Q32-7800
description	grate W 100mm D 650mm plastic-coated steel suitable for refrigerator		

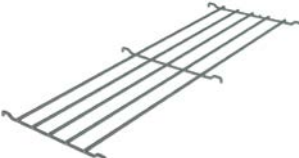
 <p>1</p>			
GEV No.	970533	Ref. No.	Q32-8060
description	grate W 120mm D 650mm plastic-coated steel suitable for refrigerator		

shelf rails and supports			
producer-specific			
 <p>1</p>			
GEV No.	690775	Ref. No.	4180314
description	guide L-shape L 440mm W 17mm H 34mm mounting pos. left/right		



1

GEV No.	690975	Ref. No.	4180234
description	guide L-shape L 570mm W 20mm H 24mm mounting pos. left		



1

GEV No.	690974	Ref. No.	4180214
description	guide L-shape L 570mm W 20mm H 24mm mounting pos. right		



1

GEV No.	700663	Ref. No.	4180124
description	guide L-shape L 642mm W 19mm H 25mm mounting pos. left		



1

GEV No.	700664	Ref. No.	4180114
description	guide L-shape L 642mm W 19mm H 25mm mounting pos. right		



1

GEV No.	700661	Ref. No.	4180104
description	guide U-shape L 460mm W 15mm mounting pos. left/right inner height 17mm		



1

GEV No.	700662	Ref. No.	400019 4080054 4180024
description	guide U-shape L 555mm W 15mm H 18mm mounting pos. left/right		
For models:	LUX 3C4, LUX34C, LUX3C2		



1

GEV No.	690772	Ref. No.	4180034
description	guide U-shape L 568mm W 15mm inner height 18mm mounting pos. left/right		
For models:	HD140A, HD70A		



1

GEV No.	690991	Ref. No.	400020 4080584 4180014
description	guide U-shape L 630mm W 15mm H 19mm mounting pos. left/right		



1

GEV No.	694921	Ref. No.	H49-0063
description	shelf support L 18mm W 23mm H 26mm Qty 1		



1

GEV No.	690969	Ref. No.	P99-0036
description	shelf support L 33/28mm W 22mm H 18mm		



1

GEV No.	694276	Ref. No.	H49-0062
description	shelf support L 34mm W 23mm H 31mm		



gaskets

refrigeration gaskets

plug-in gaskets

profile 9048

We offer custom-made gaskets for this profile

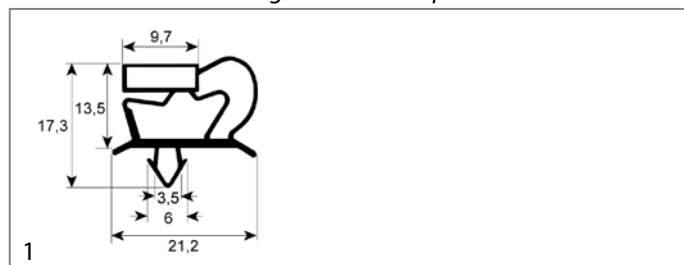

GEV No.	900621	Ref. No.	H25-0057
description	refrigeration gasket profile 9048 W 161mm L 420mm plug size		

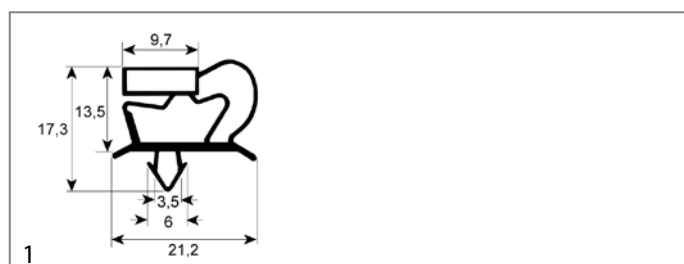

GEV No.	900619	Ref. No.	H25-0014
description	refrigeration gasket profile 9048 W 176mm L 420mm plug size		

profile 9010

We offer custom-made gaskets for this profile

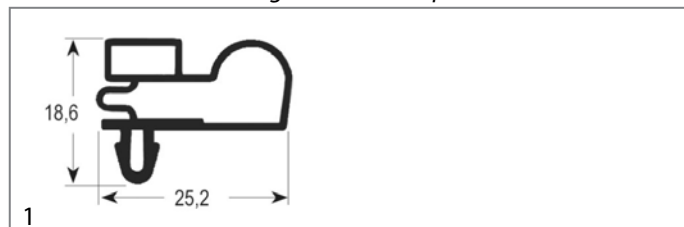

GEV No.	901249	Ref. No.	H25-0015
description	gasket profile 9010 W 650mm L 745mm plug size		

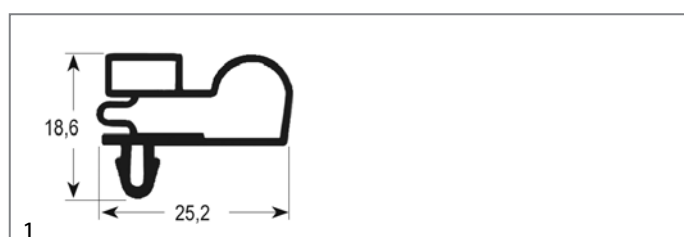

GEV No.	900622	Ref. No.	H25-0058
description	refrigeration gasket profile 9010 W 272mm L 415mm plug size		

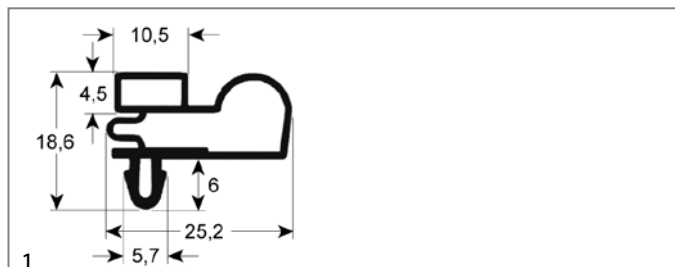

GEV No.	900596	Ref. No.	H25-0029
description	refrigeration gasket profile 9010 W 290mm L 415mm plug size		
For models:	LUX 3C4		

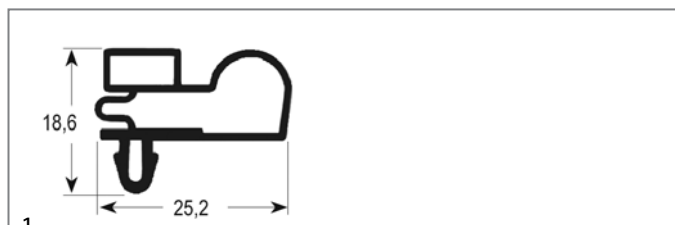

GEV No.	900623	Ref. No.	H25-0059
description	refrigeration gasket profile 9010 W 365mm L 415mm plug size		

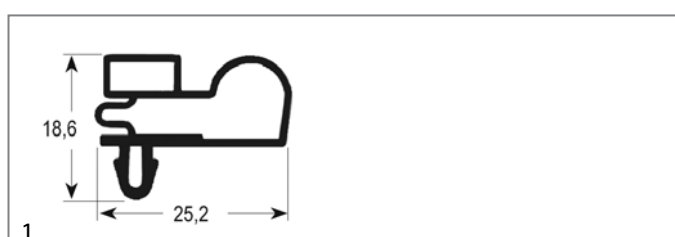

GEV No.	900620	Ref. No.	H25-0022
description	refrigeration gasket profile 9010 W 400mm L 420mm plug size		

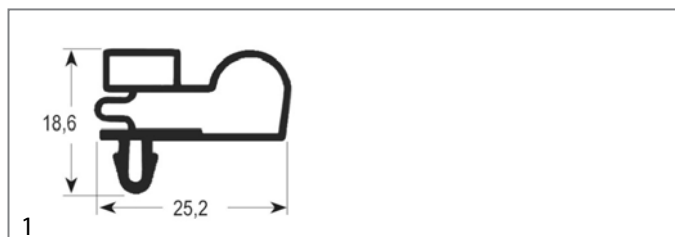

GEV No.	900597	Ref. No.	H25-0053
description	refrigeration gasket profile 9010 W 415mm L 545mm plug size		

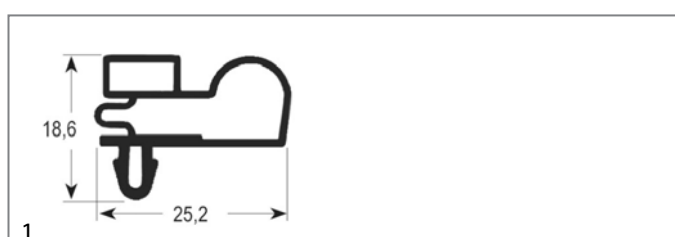

GEV No.	900595	Ref. No.	DT232-5.7.1 H25-0030
description	refrigeration gasket profile 9010 W 415mm L 625mm plug size		
For models:	LUX 3C4		

GEV No.	900616	Ref. No.	H25-0054
description	refrigeration gasket profile 9010 W 416mm L 615mm plug size		

GEV No.	901365	Ref. No.	H25-0160
description	refrigeration gasket profile 9010 W 565mm L 685mm plug size		

GEV No.	901167	Ref. No.	H25-0011
description	refrigeration gasket profile 9010 W 417mm L 600mm plug size		
For models:	SA130		

GEV No.	900598	Ref. No.	H25-0016
description	refrigeration gasket profile 9010 W 655mm L 1550mm plug size		
For models:	70N14, HD140A, HD70A, ID140		

GEV No.	900618	Ref. No.	H25-0024
description	refrigeration gasket profile 9010 W 515mm L 600mm plug size		

GEV No.	900615	Ref. No.	H25-0052
description	refrigeration gasket profile 9010 W 655mm L 755mm plug size		

GEV No.	900617	Ref. No.	H25-0032 H25-0056
description	refrigeration gasket profile 9010 W 515mm L 620mm plug size		

GEV No.	900600	Ref. No.	EISB7-19 H25-0051 H25-0081
description	refrigeration gasket profile 9010 W 660mm L 1585mm plug size		

GEV No.	900614	Ref. No.	H25-0067
description	refrigeration gasket profile 9010 W 555mm L 1400mm plug size		
For models:	AVX400NSP		

GEV No.	901502	Ref. No.	H25-0123
description	refrigeration gasket profile 9010 W 745mm L 1950mm plug size		

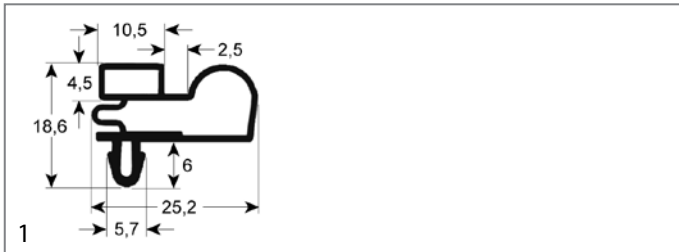

GEV No.	902251	Ref. No.	N/A
description	refrigeration gasket profile 9010 Wmm L 2500mm		

refrigeration cycle components

filter driers

miscellaneous



GEV No.	750045	Ref. No.	S06-00051
description	dryer size 20g ø 18.8mm L 144mm connection 6,5/6,5mm type Q20-Q50		

evaporators

for fridges

producer-specific



GEV No.	750253	Ref. No.	Q32-0345
description	evaporator complete with fan		

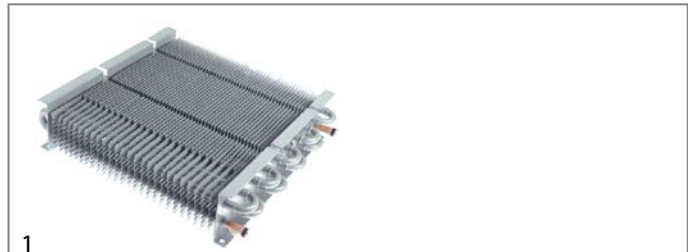

GEV No.	750181	Ref. No.	P00886 Q32-0370 TGM2G-49
description	evaporator L 360mm W 95mm H 350mm for Desmon refrigerated counter (PTR,LUX,TLM2A)		
For models:	796251, LUX 3C4		



GEV No.	750194	Ref. No.	EISB7-2 EISB7-29 EISB7-30 Q32-0081
description	evaporator L 390mm W 95mm H 350mm complete with fan		
For models:	70N14		

accessories

housings

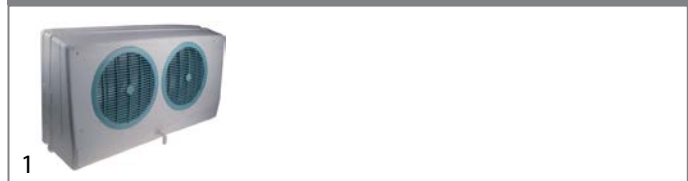

GEV No.	695610	Ref. No.	Q32-0229
description	housing for evaporator L 81.5mm W 14mm H 44mm		



GEV No.	692328	Ref. No.	Q32-0594
description	sump for evaporator L 540mm W 465mm H 112mm		

evaporation and condensing trays

evaporation trays

			
1			
GEV No.	750211	Ref. No.	Q32-0194
description	evaporation tray L 435mm W 109mm H 25mm		

			
1			
GEV No.	750282	Ref. No.	Q32-0193
description	evaporation tray L 500mm W 81mm H 49mm		

unheated condensing trays

			
1			
GEV No.	750182	Ref. No.	Q32-0195
description	condensing tray L 540mm W 235mm H 70mm		
For models:	HD70A, ID140		

			
1			
GEV No.	695609	Ref. No.	4181673
description	condensing tray stainless steel for evaporator		

kitchen accessories

gastronorm

trays and inserts

			
1			
GEV No.	993016	Ref. No.	H65-0006
description	intermediate floor GN 1/1 W 250mm L 455mm H 15mm -40 up to +100°C		

GN containers

lids

			
1			
GEV No.	993017	Ref. No.	GNC-19
description	lid SS 18/10 GN 1/9 Dmm H 23mm L 175mm W 107mm		

consumables

fuses

fine fuses

			
1			
GEV No.	358666	Ref. No.	R35-0081
description	fine fuse size ø5x20mm 0.315A fast-acting rated 250V Qty 10 pcs		

A			
axial fans		13	
B			
ballasts		5	
C			
castors and bumper angles		20	
cold air circulating fans		14	
compressors		10	
condensators & interference suppression filters		15	
condensing trays heated		12	
consumables		28	
cooling aggregates		10	
cross flow fans		15	
E			
electric accessories		15	
electronic controllers		5	
evaporation trays heated		12	
evaporators		27	
F			
fans		13	
filter driers		27	
filters		15	
fine fuses		28	
fluorescent lamps		4, 4	
fridge lamps		5	
fuses		15, 28	
G			
gastronorm		28	
grates		22	
H			
heating cables		3	
heating elements		3	
heating elements for condensate evaporation		3	
heating elements for defrosting		3	
heating elements for refrigeration		3	
L			
lamps		4	
M			
magnetic switches		4	
microswitches		4	
P			
plug-in gaskets		25	
probes		9	
R			
refrigeration cycle components		27	
refrigeration fans		13	
refrigeration gaskets		25	
refrigeration motors universal		13	
refrigeration thermostats		3	
relays		5	
rocker/momentary rocker switches		4	
S			
shelves and shelf rails		22	
solenoid valves		9	
spring assisted hinges		17	
starter		5	
switches and momentary switches		4	
T			
temperature probes		9	
terminals		15	
thermostats		3	
U			
unheated condensing trays		12	
universal probes		9	
W			
walk-in fridge catches		17	