



**GAS COMPONENTS**



**ELECTRIC COMPONENTS**



**WATER TECHNOLOGY**



**MECHANICAL COMPONENTS**



**TOOLS**

Spare parts suitable for

**EURAST**

Find the complete and up-to-date range of products in our GEV Webshop



# Manufacturer catalogue

The most important spare parts and accessories arranged clearly for every manufacturer

- ✓ Complete product range and all appliance data always up to date in the GEV Webshop
- ✓ Alphabetical Index at the end of the catalogue

## GEV Webshop

[www.gev-online.co.uk](http://www.gev-online.co.uk)

[www.gev-online.com](http://www.gev-online.com)



- 🔍 Add to Favourites
- 🔍 Sign In with email address and usual password
- 🔍 Easy-order – place several items in your basket at the same time
- 🔍 Quick Item search – no login needed



## heating elements

### heating elements for ovens

1			
<b>GEV No.</b>	419068	<b>Ref. No.</b>	2127
<b>description</b>	heating element 2400W 230V heating circuits 3 L 505mm W 355mm L1 55mm L2 450mm W1 114mm W2 127mm flange length 170mm flange width 45mm hole distance 138mm bridge length 368mm hole ø 12/7mm tube ø 8mm connection M4 connection length 30mm windings 4 rectangular flange dry heating element oven		
<b>For models:</b>	H1BPE, S4SHE		

1			
<b>GEV No.</b>	419069	<b>Ref. No.</b>	2131
<b>description</b>	heating element 4000W 230V heating circuits 3 L 505mm W 510mm L1 55mm L2 450mm W1 191.5mm W2 127mm flange length 170mm flange width 45mm hole distance 138mm bridge length 520mm hole ø 12/7mm tube ø 8mm connection M4 connection length 30mm windings 6 rectangular flange dry heating element oven		
<b>For models:</b>	H4HE		

### heating elements for fryers

#### 2 hole fixing

#### group 2

1			
<b>GEV No.</b>	419070	<b>Ref. No.</b>	2180
<b>description</b>	heating element 2200W 230V heating circuits 1 L 300mm W 110mm H 170mm L1 35mm L2 15mm L3 250mm thread M12x1.25 mounting distance 102mm tube ø 8mm windings 3 2 hole fixing connection M4 connection length 35mm fryer cover		
<b>For models:</b>	FRF10-2, FRF5		

#### group 5

1			
<b>GEV No.</b>	419067	<b>Ref. No.</b>	65720019
<b>description</b>	heating element 3000W 220V heating circuits 1 L 300mm W 205mm H 180mm 2 hole fixing connection M4 fryer heaters L1 35mm L2 15mm L3 250mm W1 42.5mm W2 120mm tube ø 8.5mm thread M12x1 mounting distance 112mm connection length 38mm windings 5		
<b>For models:</b>	FRF10-2, FRF162, FRF16-2, FRF24-2, FRF8		

### ceramic heaters

#### 245x60mm

1			
<b>GEV No.</b>	415102	<b>Ref. No.</b>	2088
<b>description</b>	ceramic emitter 400W 230V cable beaded cord L 245mm W 60mm H 35mm		
<b>For models:</b>	SCE		
<b>spare parts for</b>	415102		
		<b>GEV No.</b>	415109
		<b>Ref. No.</b>	—
			spring clip
<b>accessories for</b>	415102		
		<b>GEV No.</b>	415110
		<b>Ref. No.</b>	—
			reflector L 245mm W 95mm H 31mm thickness 0.75mm hole ø 15x40mm

### coil heating elements

1			
<b>GEV No.</b>	419071	<b>Ref. No.</b>	2264
<b>description</b>	heating element 1000W 230V L 370mm W 50mm H 25mm tube ø 8mm thread M12x1.25 connection M4 connection length 30mm dry heating element heating circuits 1 2 hole fixing		
<b>For models:</b>	SCE		



## radiation heaters



1

<b>GEV No.</b>	419076	<b>Ref. No.</b>	97032038
<b>description</b>	heating element rectangular L 840mm W 190mm 2500W 230/400V H 40mm cable length 450mm chicken rotisserie		
<b>For models:</b>	105, 105E, 1260, 1260E, 1680, 1680E, 210, 210E, 315, 315E, 420, 420E, 630, 630E, 840, 840E		

## foil heating elements



1

<b>GEV No.</b>	419075	<b>Ref. No.</b>	C5421210
<b>description</b>	foil heating element L 400mm W 290mm 1000W 230V t.max. 150°C silicone cable length 2000mm thickness 1mm bain marie		
<b>For models:</b>	BMR311, HBE, HMBE, RBE, RMBE, SBME		

## accessories

## capillary tube clips



1

<b>GEV No.</b>	550138	<b>Ref. No.</b>	68560069
<b>description</b>	capillary tube clip for pipe ø 8.5mm for circular tube heating elements		
<b>For models:</b>	FRF10-2, FRF12, FRF16-2, FRF24-2, FRF5, FRF8		

## spring clips



1

<b>GEV No.</b>	551078	<b>Ref. No.</b>	69340099
<b>description</b>	probe spring for pipe ø 8mm for probe ø 5mm L 30mm W 10mm wire gauge ø 1mm		
<b>For models:</b>	FRF10-2, FRF12, FRF16-2, FRF24-2, FRF5, FRF8		

## hot plates

## round

## with radiused edge

## for domestic and commercial kitchens



1

<b>GEV No.</b>	490018	<b>Ref. No.</b>	3216
<b>description</b>	hot plate ø 220mm 2000W 230V connection 4 screw clamps with 8mm spill ring		
<b>For models:</b>	S4E, S4SHE		



1

<b>GEV No.</b>	490020	<b>Ref. No.</b>	3235	
<b>description</b>	hot plate ø 220mm 2600W 230V connection 4 screw clamps with 8mm spill ring			
<b>For models:</b>	S4E, S4SHE			
<b>accessories for</b>	490020			
	<b>GEV No.</b>	550796	<b>Ref. No.</b>	—
	fixing plate for hot plate ø220mm			

## energy regulators

## EGO

## 1-circuit



1

<b>GEV No.</b>	380015	<b>Ref. No.</b>	C5322489
<b>description</b>	energy regulator 230V 13A single-circuit turn direction right shaft ø 6x4.6mm shaft L 23mm mounting thread M4 power release 6-100% no. 50.57021.010		
<b>For models:</b>	105, 105E, 1155, 1260, 1260E, 1575, 1680, 1680E, 210, 210E, 315, 315E, 420, 420E, 630, 630E, 840, 840E		



## thermostats

### control and safety thermostats

EGO

control thermostats

55.13\_series



1

<b>GEV No.</b>	375505	<b>Ref. No.</b>	2221
<b>description</b>	thermostat t.max. 320°C temperature range 50-320°C 1-pole 1NO 16A probe ø 3mm probe L 160mm capillary pipe 870mm capillary pipe isolatedmm gland nut shaft ø 6x4.6mm shaft L 23mm shaft position upper rotation 270°		
<b>For models:</b>	H1BE, H1BPE, H1TE, H2BE, H4HE, H8HE, R1TCE, S4SHE, SP12CE, SP4CE, SP8CE		

### IMIT / TEMPOMATIC / ARTHERMO

control thermostats



1

<b>GEV No.</b>	375939	<b>Ref. No.</b>	C5322059
<b>description</b>	thermostat t.max. 200°C temperature range 0-200°C 1-pole 1CO 16A probe ø 5mm probe L 98mm capillary pipe 1040mm capillary pipe isolatedmm gland nut shaft ø 6x4.6mm shaft L 20mm		
<b>For models:</b>	FRF102, FRF10-2, FRF12, FRF162, FRF16-2, FRF20, FRF242, FRF24-2, FRF5, FRF8		

safety thermostats



1

<b>GEV No.</b>	375941	<b>Ref. No.</b>	C5322209
<b>description</b>	safety thermostat switch-off temp. 238°C 1-pole 1NC 16A probe ø 5mm probe L 100mm capillary pipe 1050mm capillary pipe isolatedmm gland nut 250V		
<b>For models:</b>	FRF102, FRF10-2, FRF12, FRF162, FRF16-2, FRF20, FRF242, FRF24-2, FRF5, FRF8		

various

control thermostats



1

<b>GEV No.</b>	375940	<b>Ref. No.</b>	C5322579
<b>description</b>	thermostat temperature range 30-90°C 1-pole 1CO 16A probe ø 6mm probe L 108mm capillary pipe 1530mm shaft ø 6x4.6mm shaft L 12mm rotation 270° 400V		
<b>For models:</b>	HBE, HMBE, RBE, RMBE, SBME, SCE		

safety thermostats



1

<b>GEV No.</b>	390754	<b>Ref. No.</b>	92011140	
<b>description</b>	safety thermostat switch-off temp. 240°C 1-pole 0.5A probe ø 6mm probe L 79mm capillary pipe 860mm capillary pipe isolated 750mm probe thread M10x1 connection with cable cable length 600mm			
<b>For models:</b>	SF10EG, SF20EG			
<b>spare parts for</b>	390754			
	<b>GEV No.</b>	375783	<b>Ref. No.</b>	—
	safety thermostat switch-off temp. 240°C 1-pole 0.5A probe ø 6mm probe L 77mm capillary pipe 860mm capillary pipe isolated 750mm gland nut M10x1 probe SS			

### accessories

capillary tube clips



1

<b>GEV No.</b>	550138	<b>Ref. No.</b>	68560069
<b>description</b>	capillary tube clip for pipe ø 8.5mm for circular tube heating elements		
<b>For models:</b>	FRF10-2, FRF12, FRF16-2, FRF24-2, FRF5, FRF8		



## switches and momentary switches

## rocker/momentary rocker switches

ø20mm



1

<b>GEV No.</b>	357074	<b>Ref. No.</b>	C5120729
<b>description</b>	rocker switch mounting measurements 20mm red 2NO 250V 10A I O connection male faston 4.8mm ambient temperature max. 85°C protection IP40		
<b>For models:</b>	105, 105E, 1155, 1260, 1260E, 1575, 1680, 1680E, 210, 210E, 315, 315E, 420, 420E, 630, 630E, 840, 840E, AC10G, AF02, AF04, AF04G, AF12, AM20G, GH2P, H1BE, H1BPE, H2BE, H4HE, H8HE, S4SHE, SCE, TF2PG, TF3PG		

## cam switches

4-position



1

<b>GEV No.</b>	300007	<b>Ref. No.</b>	3218
<b>description</b>	cam switch 4 operating positions 1NO/2CO sequence 0-1-2-3 16A shaft ø 6x4.6mm shaft L 23mm connection male faston 6.3mm 4-position ceramic		
<b>For models:</b>	H4HE, H8HE, S2E, S4E, S4SHE		

## lamps

## indicator lights

indicator lights (complete)

ø 6mm



1

<b>GEV No.</b>	357072	<b>Ref. No.</b>	C5120219
<b>description</b>	indicator light ø 6mm 220V red connection cable 300mm cable length 300mm metal		
<b>For models:</b>	105, 105E, 1155, 1260, 1260E, 1575, 1680, 1680E, 210, 210E, 315, 315E, 420, 420E, 630, 630E, 840, 840E, FRF10-2, FRF12, FRF16-2, FRF24-2, FRF5, FRF8, H1BE, H1BPE, H1TE, H2BE, H4HE, H8HE, HBE, HMBE, HMI150E, R1TCE, RBE, RMBE, S2E, S4E, S4SHE, S4VE, SBME, SCE, SP12CE, SP4CE, SP8CE		

ø20mm



1

<b>GEV No.</b>	357073	<b>Ref. No.</b>	C5120719
<b>description</b>	indicator light ø 20mm 250V red connection male faston 4.8mm temp.-resist. 105°C		
<b>For models:</b>	AC10G, AF02, AF04, AF04G, AF12, AM20G, GH2P, TF2PG, TF3PG		

## oven lamps

universal oven lamps

55x100mm



1

<b>GEV No.</b>	101372	<b>Ref. No.</b>	C5125419	
<b>description</b>	oven lamp complete L 100mm W 55mm 230V 25W socket E14 rectangular temp.-resist. 300°C connection male faston 6.3mm			
<b>For models:</b>	105, 105E, 1155, 1260, 1260E, 1575, 1680, 1680E, 210, 210E, 315, 315E, 420, 420E, 630, 630E, 636P, 840, 840E, 848P, A4E			
<b>spare parts for</b>	101372			
	<b>GEV No.</b>	359612	<b>Ref. No.</b>	—
	<b>description</b>	light bulb t.max. 300°C socket E14 25W 230V ø 25mm L 56mm lens L 30mm for oven lamp type Philips		
	<b>GEV No.</b>	359698	<b>Ref. No.</b>	—
	<b>description</b>	lamp socket L 100mm W 55mm socket E14 connection male faston 6.3mm		
	<b>GEV No.</b>	359714	<b>Ref. No.</b>	—
	<b>description</b>	gasket for bulb socket		
	<b>GEV No.</b>	359715	<b>Ref. No.</b>	—
	<b>description</b>	lamp glass L 110mm W 65mm thickness 5mm		
	<b>GEV No.</b>	359716	<b>Ref. No.</b>	—
	<b>description</b>	frame for bulb socket		



## contactors

### LS Industrial Systems

#### power contactors



1

<b>GEV No.</b>	380944	<b>Ref. No.</b>	C5123179
<b>description</b>	power contactor resistive load 20A 230VAC (AC3/400V) 12A/5.5kW main contacts 3NO auxiliary contacts 1NO/1NC connection screw connection type GMC-12		
<b>For models:</b>	H1BE, H1TE, H2BE, R1TCE		

## electronic controllers

### miscellaneous

#### refrigeration controllers



1

<b>GEV No.</b>	378271	<b>Ref. No.</b>	C5322529
<b>description</b>	electronic controller OSAKA type T2001 AN /HSH5 mounting measurements 71x29mm 100-240V voltage AC NTC display 4 digits NTC/PTC		
<b>For models:</b>	AC10G, AF02, AF04, AF04G, AF12, AM20G, BMR311, GH2P, MC161E, MC162E, MC201E, MC202E, TF2PG, TF3PG		

## motors

### gear motors

#### for grills



1

<b>GEV No.</b>	499110	<b>Ref. No.</b>	C5020039
<b>description</b>	gear motor CROUZET 230V 50Hz 4rpm shaft ø 6x5mm L 91mm W 64mm H 58mm		
<b>For models:</b>	105, 105E, 1260, 1680, 210, 315, 420, 630, 840		



1

<b>GEV No.</b>	499111	<b>Ref. No.</b>	534027P
<b>description</b>	gear motor CEG type MM56A4-STD 90W 230V 50Hz 6500rpm L 705mm W 115mm H 550mm chicken rotisserie 0.12HP		
<b>For models:</b>	1155, 1260, 1260E, 1575, 1680, 1680E, 210, 210E, 315, 315E, 630, 630E, 840, 840E		

## gas taps

### PEL

#### 20S series



1













<b>GEV No.</b>	106840	<b>Ref. No.</b>	3780	
<b>description</b>	gas tap PEL type 20S gas inlet pipe flange ø21mm bypass nozzle ø 0mm gas outlet M16x1.5 (tube ø 10/8mm) thermocouple connection M8x1 pilot connection shaft ø 8x6.5mm shaft L 22/15mm shaft flat upper			
<b>For models:</b>	105, 105E, 1155, 1260, 1260E, 1575, 1680, 1680E, 210, 210E, 315, 315E, 420, 420E, 630, 630E, 840, 840E			
<b>spare parts for</b>	106840			
	<b>GEV No.</b>	101060	<b>Ref. No.</b>	—
	magnet unit standard L 39mm D1 ø 15.4mm D2 ø 11mm suitable for PEL20-21/JUNKERS/EGA			
	<b>GEV No.</b>	101205	<b>Ref. No.</b>	—
	gas tap front part shaft ø 8x6.5mm shaft L 22/15mm shaft flat upper/lower suitable for PEL20			
	<b>GEV No.</b>	101880	<b>Ref. No.</b>	—
	gasket Viton ED ø 14mm ID ø 9mm thickness 7.7mm Qty 1 pcs			
	<b>GEV No.</b>	106202	<b>Ref. No.</b>	—
	bypass nozzle type PEL20/21 bore ø 0mm thread M5x0.5			
<b>accessories for</b>	106840			
	<b>GEV No.</b>	101230	<b>Ref. No.</b>	—
	thermocouple nut T1: M8x1 T2: M18x1 aluminium			
	<b>GEV No.</b>	101278	<b>Ref. No.</b>	3781
	olive for pipe ø 10mm Qty 1 pcs			
	<b>GEV No.</b>	101300	<b>Ref. No.</b>	3782
	union nut thread M16x1.5 tube ø 10mm			
	<b>GEV No.</b>	101450	<b>Ref. No.</b>	—
	olive for pipe ø 8mm L 12.7mm Qty 1 pcs ED ø 10mm			
	<b>GEV No.</b>	101451	<b>Ref. No.</b>	—
	union nut thread M16x1.5 tube ø 8mm			



## 21S series







1

<b>GEV No.</b>	106841	<b>Ref. No.</b>	C5811429
<b>description</b>	gas tap PEL type 21S gas inlet pipe flange ø21mm bypass nozzle ø 0mm gas outlet M16x1.5 (tube ø 10mm) thermocouple connection M9x1 pilot connection M10x1 shaft ø 8x6.5mm shaft L 22/15mm shaft flat right pipe input ø 9mm		
<b>For models:</b>	C8L, H1FV, H1PH, H4H, H6H, HBG, HCP, HGR, HGR2, HM100, HM150, HMI100, HMI150, R2T, R4H, R6L, RBG, RBP, RCP, RM70, S2, S2P, S2SH, S4, S4SH, SBG, SBP		
<b>spare parts for</b>	106841		
	<b>GEV No.</b>	101060	<b>Ref. No.</b> —
	magnet unit standard L 39mm D1 ø 15.4mm D2 ø 11mm suitable for PEL20-21/JUNKERS/EGA		
	<b>GEV No.</b>	101231	<b>Ref. No.</b> —
	thermocouple nut T1: M9x1 T2: M18x1		
	<b>GEV No.</b>	106202	<b>Ref. No.</b> —
	bypass nozzle type PEL20/21 bore ø 0mm thread M5x0.5		
<b>accessories for</b>	106841		
	<b>GEV No.</b>	100908	<b>Ref. No.</b> —
	union screw thread M10x1 for pipe ø 4mm Qty 1 pcs		
	<b>GEV No.</b>	100909	<b>Ref. No.</b> A1018997
	union screw thread M10x1 for pipe ø 6mm Qty 1 pcs		
	<b>GEV No.</b>	101246	<b>Ref. No.</b> —
	olive for pipe ø 4mm Qty 1 pcs		
	<b>GEV No.</b>	101278	<b>Ref. No.</b> 3781
	olive for pipe ø 10mm Qty 1 pcs		
	<b>GEV No.</b>	101286	<b>Ref. No.</b> —
	olive ID ø 6mm Qty 1 pcs		
	<b>GEV No.</b>	101300	<b>Ref. No.</b> 3782
	union nut thread M16x1.5 tube ø 10mm		
	<b>GEV No.</b>	101450	<b>Ref. No.</b> —
	olive for pipe ø 8mm L 12.7mm Qty 1 pcs ED ø 10mm		
	<b>GEV No.</b>	101451	<b>Ref. No.</b> —
	union nut thread M16x1.5 tube ø 8mm		
	<b>GEV No.</b>	110081	<b>Ref. No.</b> —
	knob ø 70mm shaft ø 8x6.5mm shaft flat universal		
	<b>GEV No.</b>	112206	<b>Ref. No.</b> —
	knob dial plate silver gas tap PEL21/22/23 t.max.°C ED ø 63mm ID ø 45.5mm		

## SABAF



1

<b>GEV No.</b>	106842	<b>Ref. No.</b>	C5816299
<b>description</b>	gas tap SABAF type 10 gas inlet pipe flange ø23mm bypass nozzle ø 0mm gas outlet 1/4" (tube ø 8mm) front fixing M13x1 thermocouple connection M8x1 shaft ø 8x6.5mm shaft L 32/12.5mm shaft flat right		
<b>For models:</b>	1155, 1575, 315, 420, 630, 636P, 840, 848P, FOK30, FOK60, FOK90, PC100, PC100C, PC100F, PC60, PC60C, PC60F, PC80, PC80C, PC80F		
<b>spare parts for</b>	106842		
	<b>GEV No.</b>	101051	<b>Ref. No.</b> —
	magnet unit L 27mm D1 ø 12.5mm D2 ø 8.5mm suitable for JUNKERS/EGA/MADEC/SABAF standard		
	<b>GEV No.</b>	101376	<b>Ref. No.</b> —
	gasket ID ø 8mm ED ø 12mm H 3/5mm		
<b>accessories for</b>	106842		
	<b>GEV No.</b>	101277	<b>Ref. No.</b> C5815549
	olive ID ø 8mm Qty 1 pcs		
	<b>GEV No.</b>	101751	<b>Ref. No.</b> —
	bracket		
	<b>GEV No.</b>	520656	<b>Ref. No.</b> —
	union nut thread 1/4" tube ø 6/8mm		



1

<b>GEV No.</b>	106843	<b>Ref. No.</b>	C5816289
<b>description</b>	gas tap SABAF type 10 gas inlet pipe flange ø23mm bypass nozzle ø 0mm gas outlet 1/4" (tube ø 8mm) front fixing thermocouple connection M8x1 shaft ø 8x6.5mm shaft L 47/12.5mm shaft flat right		
<b>For models:</b>	S3SB		
<b>spare parts for</b>	106843		
	<b>GEV No.</b>	101051	<b>Ref. No.</b> —
	magnet unit L 27mm D1 ø 12.5mm D2 ø 8.5mm suitable for JUNKERS/EGA/MADEC/SABAF standard		
	<b>GEV No.</b>	101376	<b>Ref. No.</b> —
	gasket ID ø 8mm ED ø 12mm H 3/5mm		
<b>accessories for</b>	106843		
	<b>GEV No.</b>	101277	<b>Ref. No.</b> C5815549
	olive ID ø 8mm Qty 1 pcs		
	<b>GEV No.</b>	101751	<b>Ref. No.</b> —
	bracket		
	<b>GEV No.</b>	520656	<b>Ref. No.</b> —
	union nut thread 1/4" tube ø 6/8mm		









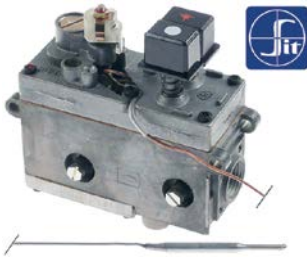

## gas thermostats

### SIT

#### 710 Minisit series



<b>GEV No.</b>	101132	<b>Ref. No.</b>	3103
<b>description</b>	gas thermostat SIT type MINISIT 710 t.max. 340°C 100-340°C gas inlet 1/2" gas outlet 3/8" thermocouple connection M9x1 pilot connection M10x1 probe ø 5mm probe L 68mm capillary pipe 1050mm probe type type B1 pressure controller no pressure regulator mbar gland nut ignition gas no		
<b>For models:</b>	C8L, H1B, H1FV, H1L, H2B, H4H, H6H, HF20, HSB120, HSB80, R1T, R1TC, R4H, R6L, SP12C, SP4C, SP8C		
<b>spare parts for</b>	101132		
	<b>GEV No.</b>	101053	<b>Ref. No.</b> —
	magnet unit T1: M9x1 T2: M24x1 L 45mm ø 17mm suitable for Minisit		
	<b>GEV No.</b>	102102	<b>Ref. No.</b> —
	probe 100-340°C probe ø 5mm probe L 68mm capillary pipe 1750mm t.max. 340°C oven/grill probe type type B1 suitable for MINISIT 710		
<b>accessories for</b>	101132		
	<b>GEV No.</b>	100809	<b>Ref. No.</b> 3785
	O-ring EPDM thickness 2mm ID ø 21mm Qty 1 pcs		
	<b>GEV No.</b>	100904	<b>Ref. No.</b> —
	locking screw M10x1 for pipe ø 4mm Qty 1 pcs		
	<b>GEV No.</b>	100905	<b>Ref. No.</b> C5815359
	locking screw M10x1 for pipe ø 6mm Qty 1 pcs		
	<b>GEV No.</b>	101054	<b>Ref. No.</b> —
	magnet unit T1: M10x1 T2: M24x1 L 45mm ø 17mm suitable for Minisit		
	<b>GEV No.</b>	101136	<b>Ref. No.</b> —
	piezoelectric igniter suitable for Minisit with cover cap ømm connection F6.3x0.8		
	<b>GEV No.</b>	101137	<b>Ref. No.</b> —
	cover cap without piezoelectric igniter		
	<b>GEV No.</b>	101267	<b>Ref. No.</b> —
	reducer IT 3/8" ET 1/2" L 21mm		
	<b>GEV No.</b>	101268	<b>Ref. No.</b> —
	gas connection thread 3/8" angled with O-ring MINISIT 710		
	<b>GEV No.</b>	101269	<b>Ref. No.</b> —
	gas connection thread 1/2" angled with O-ring MINISIT 710		
	<b>GEV No.</b>	101270	<b>Ref. No.</b> —
	screw connection IT 3/8" ET 3/8" L 28mm		
	<b>GEV No.</b>	101272	<b>Ref. No.</b> —
	screw connection IT 1/2" ET 3/8" L 57mm		

<b>accessories for</b>	101132		
	<b>GEV No.</b>	101273	<b>Ref. No.</b> —
	olive for pipe ø 12mm L 9.5mm brass Qty 1 pcs suitable for universal		
	<b>GEV No.</b>	101274	<b>Ref. No.</b> —
	olive for pipe ø 16mm Qty 1 pcs		
	<b>GEV No.</b>	101275	<b>Ref. No.</b> —
	union screw thread 1/2" for pipe ø 16mm Qty 1 pcs		
	<b>GEV No.</b>	101276	<b>Ref. No.</b> —
	union screw thread 3/8" tube ø 12mm Qty 1 pcs		
	<b>GEV No.</b>	110068	<b>Ref. No.</b> —
	knob suitable for Minisit ø 37mm		

## gas valves and ignition boxes

### gas control valves

#### SIT

#### NOVASIT

#### accessories

	<b>GEV No.</b>	100905	<b>Ref. No.</b>	C5815359
	locking screw M10x1 for pipe ø 6mm Qty 1 pcs			
	<b>For models:</b> H1B, H1FV, H1L, H1PH, H2B, H4H, H6H, HBG, HCP, HF20, HF40, HGR, HGR2, HM100, HM150, HMI100, HMI150, HSB120, HSB80, R1T, R1TC, R2T, R4H, R6L, RBG, RBP, RCP, RM70, S2, S2P, S2SH, S4, S4SH, SBG, SBP, SF10EG, SF20EG, SP12C, SP4C, SP8C			

## ignition parts

### pilot burners

#### SIT

#### 100 series

#### accessories

#### pilot burner brackets

#### universal

	<b>GEV No.</b>	100894	<b>Ref. No.</b>	3705
	opposite support for pilot burner suitable for 100 series			
	<b>For models:</b> H1BP, S3SB, S4SH			



1

<b>GEV No.</b>	100893	<b>Ref. No.</b>	3786
<b>description</b>	pilot burner bracket suitable for 100 series 2-piece		
<b>For models:</b>	H1BP, S3SB, S4SH		



1

<b>GEV No.</b>	100888	<b>Ref. No.</b>	3704
<b>description</b>	screw bolt for pilot burner		
<b>For models:</b>	H1BP, S3SB		

## miscellaneous



1

<b>GEV No.</b>	100885	<b>Ref. No.</b>	C5815189
<b>description</b>	air mixing sleeve for pilot burner Qty 1 pcs		
<b>For models:</b>	C8L, H1PH, H4H, H6H, HGR, HGR2, R2T, R4H, R6L, S2, S2P, S2SH, S4, S4SH		

## POLIDORO

## pilot burners



1

<b>GEV No.</b>	106837	<b>Ref. No.</b>	C5810129
<b>description</b>	pilot burner POLIDORO 3 flames natural gas code 27.2		
<b>For models:</b>	C8L, H1B, H1FV, H1L, H2B, H4H, H6H, HBG, HCP, HF20, HF40, HM100, HM150, HMI100, HMI150, HSB120, HSB80, R1T, R1TC, R4H, R6L, RBG, RBP, RCP, RM70, SBG, SBP, SF10EG, SF20EG, SP12C, SP4C, SP8C		

## producer-specific pilot burners

## EURAST





1

<b>GEV No.</b>	107485	<b>Ref. No.</b>	C5815249M	
<b>description</b>	pilot burner LPG code 20			
<b>For models:</b>	H1PH, H4H, H6H, HGR, HGR2, R4H, S2, S2P, S2SH, S4, S4SH			
<b>spare parts for</b>	107485			
	<b>GEV No.</b>	100245	<b>Ref. No.</b>	—
	<b>description</b>	pilot burner nozzle LPG code 20 bore ø 0.2mm Qty 1 pcs thread M8x0.75		
	<b>GEV No.</b>	100885	<b>Ref. No.</b>	C5815189
	<b>description</b>	air mixing sleeve for pilot burner Qty 1 pcs		
	<b>GEV No.</b>	100904	<b>Ref. No.</b>	—
	<b>description</b>	locking screw M10x1 for pipe ø 4mm Qty 1 pcs		
	<b>GEV No.</b>	100905	<b>Ref. No.</b>	C5815359
	<b>description</b>	locking screw M10x1 for pipe ø 6mm Qty 1 pcs		
	<b>GEV No.</b>	106844	<b>Ref. No.</b>	C5815249 C5815309
	<b>description</b>	pilot burner 1 flame		
	<b>GEV No.</b>	106845	<b>Ref. No.</b>	C5815099
	<b>description</b>	pilot burner centre part ø 8mm		
	<b>GEV No.</b>	107483	<b>Ref. No.</b>	C5815169
	<b>description</b>	pilot burner bottom part LPG code 20		
	<b>GEV No.</b>	697942	<b>Ref. No.</b>	C5815279
	<b>description</b>	gasket for pilot burner ø 35.5mm thickness 1mm		

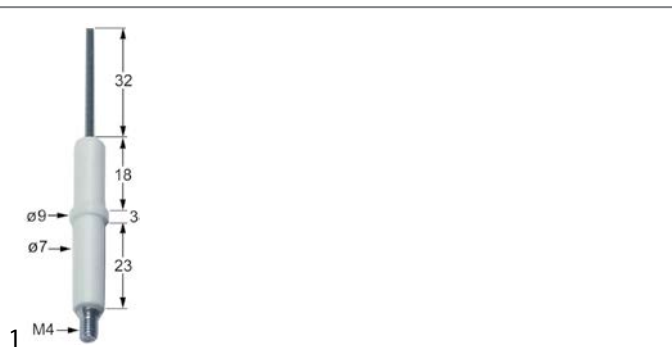

electrodes



<b>GEV No.</b>	100701	<b>Ref. No.</b>	C5810139
<b>description</b>	ignition electrode connection M4 Qty 1 pcs		
<b>For models:</b>	C8L, H1B, H1FV, H1L, H2B, H4H, H6H, HBG, HCP, HF20, HF40, HM100, HM150, HMI100, HMI150, HSB120, HSB80, R1T, R1TC, R4H, R6L, RBG, RBP, RCP, RM70, SBG, SBP, SF10EG, SF20EG, SP12C, SP4C, SP8C		
<b>accessories for</b>	100701		
		<b>GEV No.</b>	100906
		<b>Ref. No.</b>	A1018998
	screw connection thread M10x1 for ignition electrode brass Qty 1 pcs WS 10		

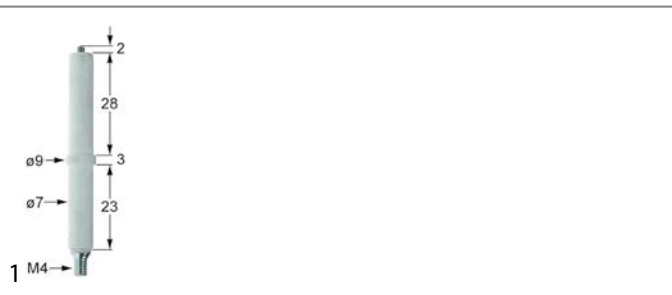

<b>GEV No.</b>	102314	<b>Ref. No.</b>	96010061
<b>description</b>	ignition electrode D1 ø 7mm D2 ø 9mm connection M4 L1 2mm BL1 28mm BL2 3mm BL3 23mm to clip		
<b>For models:</b>	HCP, RCP		



<b>GEV No.</b>	100906	<b>Ref. No.</b>	A1018998
<b>description</b>	screw connection thread M10x1 for ignition electrode brass Qty 1 pcs WS 10		
<b>For models:</b>	C8L, H1B, H1FV, H1L, H2B, H4H, H6H, HBG, HCP, HF20, HM100, HM150, HMI100, HMI150, HSB120, HSB80, R1T, R1TC, R4H, R6L, RBG, RBP, RCP, RM70, SBG, SBP, SF10EG, SF20EG, SP12C, SP4C, SP8C		

ignition cables

pre-assembled cables



<b>GEV No.</b>	102164	<b>Ref. No.</b>	2175
<b>description</b>	ignition cable cable length 1000mm connection F6.3mm / lug M4		
<b>For models:</b>	C8L, H1B, H1BP, H1FV, H1L, H2B, H4H, H6H, HBG, HCP, HF40, HM100, HM150, HMI100, HMI150, R4H, R6L, RBG, RBP, RCP, RM70, S3SB, S4SH, SBG, SBP, SP12C, SP8C		

<b>GEV No.</b>	102177	<b>Ref. No.</b>	2193
<b>description</b>	ignition cable cable length 600mm connection F6.3mm / lug M4		
<b>For models:</b>	H1FV, HBG, HSB120, HSB80, R1T, R1TC, SF10EG, SF20EG, SP12C, SP4C, SP8C		

piezoelectric igniters

miscellaneous



<b>GEV No.</b>	nla <sup>1</sup>	<b>Ref. No.</b>	3747
<b>description</b>	piezoelectric igniter suitable for Minisit connection F6.3x0.8 ømm		
<b>For models:</b>	C8L, H1FV, H1L, H4H, H6H, HBG, HM150, HSB120, HSB80, R1TC, R4H, R6L, S3SB, SBG, SBP, SF20EG, SP12C, SP4C, SP8C		

<sup>1</sup>no longer available

thermocouples



plug-in thermocouples

plug-in thermocouples standard

with barrel socket ø6(6.5)mm

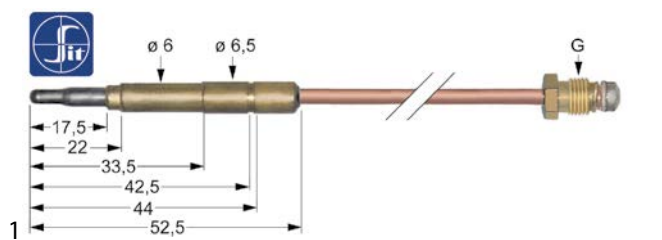
thermocouples SIT



<b>GEV No.</b>	107602	<b>Ref. No.</b>	C5811809
<b>description</b>	thermocouple SIT M8x1 L 850mm plug connection ø6.0(6.5)mm		
<b>For models:</b>	H1BP, S3SB, S4SH		
<b>accessories for</b>	107602		
		<b>GEV No.</b>	100920
		<b>Ref. No.</b>	—
	thermocouple fitting thread M8x1 / M9x1 Qty 1 pcs		
		<b>GEV No.</b>	100922
		<b>Ref. No.</b>	—
	thermocouple fitting thread M10x1 / ASA 11/32 Qty 1 pcs		

<b>GEV No.</b>	107612	<b>Ref. No.</b>	C5811009
<b>description</b>	thermocouple SIT M9x1 L 1000mm plug connection $\phi 6.0(6.5)$ mm		
<b>For models:</b>	H1FV		

<b>GEV No.</b>	107611	<b>Ref. No.</b>	C5811679
<b>description</b>	thermocouple SIT M9x1 L 850mm plug connection $\phi 6.0(6.5)$ mm		
<b>For models:</b>	H1B, H1L, H2B, H4H		

<b>GEV No.</b>	107614	<b>Ref. No.</b>	C5811059
<b>description</b>	thermocouple SIT M9x1 L 1500mm plug connection $\phi 6.0(6.5)$ mm		
<b>For models:</b>	HM100, HM150, HMI100, HMI150, R4H, RM70		

threaded thermocouples  
 threaded thermocouples standard  
 with socket with thread M8x1  
 SIT

<b>GEV No.</b>	107606	<b>Ref. No.</b>	C5820049
<b>description</b>	thermocouple SIT M9x1 L 320mm plug connection $\phi 6.0(6.5)$ mm		
<b>For models:</b>	105, 10P, 1260, 1680, 20P, 210, 30P, 315, 40P, 420, 5P, 630, 840, HBG, HSB120, HSB80, R1T, R1TC, SF10EG, SF20EG, SP12C, SP4C, SP8C		

<b>GEV No.</b>	107628	<b>Ref. No.</b>	C5811019
<b>description</b>	thermocouple SIT M8x1 L 320mm M8x1		
<b>For models:</b>	FOK30, FOK60, FOK90, H4H, H6H, PC100, PC100C, PC100F, PC60, PC60C, PC60F, PC80, PC80C, PC80F, R4H, S2, S2P, S2SH, S3SB, S4, S4SH		
<b>accessories for</b>	107628		
		<b>GEV No.</b>	102067
		<b>Ref. No.</b>	C5811029
	nut thread M8x1 H 3mm brass Qty 1 pcs type SEF 1		

<b>GEV No.</b>	107609	<b>Ref. No.</b>	C5811829
<b>description</b>	thermocouple SIT M9x1 L 600mm plug connection $\phi 6.0(6.5)$ mm		
<b>For models:</b>	C8L, H1BP, H1FV, H1L, H4H, H6H, HBG, HCP, HM150, R4H, R6L, RBG, RBP, RCP, S4SH, SBG, SBP, SF20EG, SP12C, SP8C		

<b>GEV No.</b>	107629	<b>Ref. No.</b>	C5811039
<b>description</b>	thermocouple SIT M8x1 L 450mm M8x1		
<b>For models:</b>	105, 105E, 1155, 1260, 1260E, 1575, 1680, 1680E, 210, 210E, 315, 315E, 420, 420E, 630, 630E, 840, 840E		
<b>accessories for</b>	107629		
		<b>GEV No.</b>	102067
		<b>Ref. No.</b>	C5811029
	nut thread M8x1 H 3mm brass Qty 1 pcs type SEF 1		

<b>GEV No.</b>	107638	<b>Ref. No.</b>	C5811049
<b>description</b>	thermocouple SIT M9x1 L 1000mm M8x1		
<b>For models:</b>	C8L, H4H, R4H		



<b>GEV No.</b>	107635	<b>Ref. No.</b>	C5811739
<b>description</b>	thermocouple SIT M9x1 L 320mm M8x1		
<b>For models:</b>	HGR		
<b>accessories for</b>	107635		
	<b>GEV No.</b>	102067	<b>Ref. No.</b> C5811029
	nut thread M8x1 H 3mm brass Qty 1 pcs type SEF 1		

<b>GEV No.</b>	107636	<b>Ref. No.</b>	C5811849
<b>description</b>	thermocouple SIT M9x1 L 600mm M8x1		
<b>For models:</b>	HGR2		
<b>accessories for</b>	107636		
	<b>GEV No.</b>	102067	<b>Ref. No.</b> C5811029
	nut thread M8x1 H 3mm brass Qty 1 pcs type SEF 1		

type Junkers with aluminised tip

<b>GEV No.</b>	102233	<b>Ref. No.</b>	C5811129
<b>description</b>	thermocouple M8x1 L 750mm M8x1		
<b>For models:</b>	H4H, H6H		
<b>accessories for</b>	102233		
	<b>GEV No.</b>	102067	<b>Ref. No.</b> C5811029
	nut thread M8x1 H 3mm brass Qty 1 pcs type SEF 1		

accessories

nuts

<b>GEV No.</b>	102067	<b>Ref. No.</b>	C5811029
<b>description</b>	nut thread M8x1 H 3mm brass Qty 1 pcs type SEF 1		
<b>For models:</b>	105, 105E, 1155, 1260, 1260E, 1575, 1680, 1680E, 210, 210E, 315, 315E, 420, 420E, 630, 630E, 636P, 840, 840E, 848P, FOK30, FOK60, FOK90, PC100, PC100C, PC100F, PC60, PC60C, PC60F, PC80, PC80C, PC80F, S3SB		

## gas burners

### hob burners

#### universal hob burners

##### ARC

##### 65 series

<b>GEV No.</b>	104328	<b>Ref. No.</b>	C5815139
<b>description</b>	burner pipe 4.5kW L 93mm total length 108mm air mixer ø 18.2mm ED ø 32.9mm ID ø 22.7mm		
<b>For models:</b>	C8L, H4H, H6H, R2T, R4H, R6L, S2, S2P, S2SH, S4, S4SH		

##### SABAF

##### 1 series

<b>GEV No.</b>	104288	<b>Ref. No.</b>	C5815589
<b>description</b>	burner cap 3.6kW ø 120mm		
<b>For models:</b>	FOK30, FOK60, FOK90		
<b>accessories for</b>	104288		
	<b>GEV No.</b>	104289	<b>Ref. No.</b> C5815609
	burner lower part 3/3.6kW for burner cap ø 90/120mm		
	<b>GEV No.</b>	105086	<b>Ref. No.</b> C5815579
	burner ring 3.6kW for burner cap ø 120mm		
	<b>GEV No.</b>	105087	<b>Ref. No.</b> C5815599
	burner head 3.6kW for burner cap ø 120mm		

<b>GEV No.</b>	105087	<b>Ref. No.</b>	C5815599
<b>description</b>	burner head 3.6kW for burner cap ø 120mm		
<b>For models:</b>	FOK30, FOK60, FOK90		
<b>accessories for</b>	105087		
	<b>GEV No.</b>	104288	<b>Ref. No.</b> C5815589
	burner cap 3.6kW ø 120mm		
	<b>GEV No.</b>	105085	<b>Ref. No.</b> —
	burner cap ø 120mm		
	<b>GEV No.</b>	105086	<b>Ref. No.</b> C5815579
	burner ring 3.6kW for burner cap ø 120mm		
	<b>GEV No.</b>	105088	<b>Ref. No.</b> —
	burner cap A ø 110mm with central hole		
	<b>GEV No.</b>	105089	<b>Ref. No.</b> —
	burner ring 3kW for burner cap ø 90mm		

			
1			
<b>GEV No.</b>	104289	<b>Ref. No.</b>	C5815609
<b>description</b>	burner lower part 3/3.6kW for burner cap ø 90/120mm		
<b>For models:</b>	FOK30, FOK60, FOK90		
<b>accessories for</b>	104289		
	<b>GEV No.</b>	104286	<b>Ref. No.</b> —
	burner cap 3kW ø 90mm		
	<b>GEV No.</b>	104288	<b>Ref. No.</b> C5815589
	burner cap 3.6kW ø 120mm		
	<b>GEV No.</b>	105086	<b>Ref. No.</b> C5815579
	burner ring 3.6kW for burner cap ø 120mm		
	<b>GEV No.</b>	105087	<b>Ref. No.</b> C5815599
	burner head 3.6kW for burner cap ø 120mm		
	<b>GEV No.</b>	105089	<b>Ref. No.</b> —
	burner ring 3kW for burner cap ø 90mm		
	<b>GEV No.</b>	105090	<b>Ref. No.</b> —
	burner head 3kW for burner cap ø 90mm		
	<b>GEV No.</b>	106482	<b>Ref. No.</b> —
	gas injector thread M6x0.75 WS 7 bore ø 1.1mm		
	<b>GEV No.</b>	106485	<b>Ref. No.</b> —
	gas injector thread M6x0.75 WS 7 bore ø 1.6mm		

			
1			
<b>GEV No.</b>	105086	<b>Ref. No.</b>	C5815579
<b>description</b>	burner ring 3.6kW for burner cap ø 120mm		
<b>For models:</b>	FOK30, FOK60, FOK90		
<b>accessories for</b>	105086		
	<b>GEV No.</b>	105085	<b>Ref. No.</b> —
	burner cap ø 120mm		
	<b>GEV No.</b>	105087	<b>Ref. No.</b> C5815599
	burner head 3.6kW for burner cap ø 120mm		
	<b>GEV No.</b>	105088	<b>Ref. No.</b> —
	burner cap A ø 110mm with central hole		
	<b>GEV No.</b>	105089	<b>Ref. No.</b> —
	burner ring 3kW for burner cap ø 90mm		

tube burners

			
1			
<b>GEV No.</b>	104414	<b>Ref. No.</b>	C5815399
<b>description</b>	tubular burner ø 74mm L 180mm thread 3/8" H 52mm ID ø 25mm W 74mm		
<b>For models:</b>	SF10EG, SF20EG		

ceramic burners

			
1			
<b>GEV No.</b>	101938	<b>Ref. No.</b>	530587M 534030P
<b>description</b>	ceramic burner L 845mm W 86mm firing range 61x801mm chicken rotisserie		
<b>For models:</b>	105, 105E, 1155, 1260, 1260E, 1575, 1680, 1680E, 210, 210E, 315, 315E, 420, 420E, 630, 630E, 840, 840E		

gas nozzles

main nozzles

gas nozzles M10x1



			
1			
<b>GEV No.</b>	107827	<b>Ref. No.</b>	C5812660
<b>description</b>	gas injector thread M10x1 WS 12 bore ø 1.45mm GN		
<b>For models:</b>	H1FV, H1PH, HGR, HGR2		

			
1			
<b>GEV No.</b>	107828	<b>Ref. No.</b>	C5812680
<b>description</b>	gas injector thread M10x1 WS 12 bore ø 1.9mm GLP		
<b>For models:</b>	1155, 1575, 315, 420, 630, 636P, 840, 848P, H1FV, H1PH, HGR, HGR2		



			
1			
<b>GEV No.</b>	107826	<b>Ref. No.</b>	C5812640
<b>description</b>	gas injector thread M10x1 WS 12 bore ø 1mm GLP		
<b>For models:</b>	H1FV, H1PH, HGR, HGR2		

			
1			
<b>GEV No.</b>	107829	<b>Ref. No.</b>	C5812689
<b>description</b>	gas injector thread M10x1 WS 12 bore ø 2.2mm GN		
<b>For models:</b>	H1PH, HGR2		

<b>accessories for</b>	101278			
	<b>GEV No.</b>	101300	<b>Ref. No.</b>	3782
	union nut thread M16x1.5 tube ø 10mm			
	<b>GEV No.</b>	101478	<b>Ref. No.</b>	—
	union nut thread 3/8" for pipe ø 10mm			

			
1			
<b>GEV No.</b>	102797	<b>Ref. No.</b>	A1018999
<b>description</b>	olive for pipe ø 6mm Qty 1 pcs		
<b>For models:</b>	C8L, H1B, H1FV, H1L, H2B, H4H, H6H, HBG, HCP, HF20, HF40, HM100, HM150, HMI100, HMI150, HSB120, HSB80, R1T, R1TC, R4H, R6L, RBG, RBP, RCP, RM70, SBG, SBP, SF10EG, SF20EG, SP12C, SP4C, SP8C		

## pilot burner nozzles

### pilot burner nozzles POLIDORO

			
1			
<b>GEV No.</b>	100000	<b>Ref. No.</b>	C5810169
<b>description</b>	pilot burner nozzle POLIDORO LPG code 22 bore ø 0.22mm Qty 1 pcs		
<b>For models:</b>	C8L, H1B, H1FV, H1L, H2B, H4H, H6H, HBG, HCP, HF20, HF40, HM100, HM150, HMI100, HMI150, HSB120, HSB80, R1T, R1TC, R4H, R6L, RBG, RBP, RCP, RM70, SBG, SBP, SF10EG, SF20EG, SP12C, SP4C, SP8C		

			
1			
<b>GEV No.</b>	106703	<b>Ref. No.</b>	C5810159
<b>description</b>	pilot burner nozzle POLIDORO natural gas code 27.2 bore ø 2x0.27mm Qty 1 pcs		
<b>For models:</b>	C8L, H1B, H1FV, H1L, H2B, H4H, H6H, HBG, HCP, HF20, HF40, HM100, HM150, HMI100, HMI150, HSB120, HSB80, R1T, R1TC, R4H, R6L, RBG, RBP, RCP, RM70, SBG, SBP, SF10EG, SF20EG, SP12C, SP4C, SP8C		

### union nuts

			
1			
<b>GEV No.</b>	101296	<b>Ref. No.</b>	C5815539
<b>description</b>	union nut thread M12x1 for pipe ø 8mm		
<b>For models:</b>	S35B		

<b>accessories for</b>	101296			
	<b>GEV No.</b>	101277	<b>Ref. No.</b>	C5815549
	olive ID ø 8mm Qty 1 pcs			



			
1			
<b>GEV No.</b>	101300	<b>Ref. No.</b>	3782
<b>description</b>	union nut thread M16x1.5 tube ø 10mm		
<b>For models:</b>	C8L, H1B, H1FV, H1L, H1PH, H2B, H4H, H6H, HBG, HCP, HF20, HF40, HGR, HGR2, HM100, HM150, HMI100, HMI150, HSB120, HSB80, PC100, PC100C, PC100F, PC80, PC80C, PC80F, R1T, R1TC, R2T, R4H, R6L, RBG, RBP, RCP, RM70, S2, S2P, S2SH, S4, S4SH, SBG, SBP, SF10EG, SF20EG, SP12C, SP4C, SP8C		

<b>accessories for</b>	101300			
	<b>GEV No.</b>	101278	<b>Ref. No.</b>	3781
	olive for pipe ø 10mm Qty 1 pcs			

## auxiliary gas parts

### screw connections

#### olives



				
1				
<b>GEV No.</b>	101278	<b>Ref. No.</b>	3781	
<b>description</b>	olive for pipe ø 10mm Qty 1 pcs			
<b>For models:</b>	C8L, H1B, H1FV, H1L, H1PH, H2B, H4H, H6H, HBG, HCP, HF20, HF40, HGR, HGR2, HM100, HM150, HMI100, HMI150, HSB120, HSB80, PC100, PC100C, PC100F, PC80, PC80C, PC80F, R1T, R1TC, R2T, R4H, R6L, RBG, RBP, RCP, RM70, S2, S2P, S2SH, S4, S4SH, SBG, SBP, SF10EG, SF20EG, SP12C, SP4C, SP8C			
<b>accessories for</b>	101278			
	<b>GEV No.</b>	100943	<b>Ref. No.</b>	—
	union nut thread M17x1 tube ø 10mm			

union screws

			
1			
<b>GEV No.</b>	100905	<b>Ref. No.</b>	C5815359
<b>description</b>	locking screw M10x1 for pipe ø 6mm Qty 1 pcs		
<b>For models:</b>	H1B, H1FV, H1L, H1PH, H2B, H4H, H6H, HBG, HCP, HF20, HF40, HGR, HGR2, HM100, HM150, HMI100, HMI150, HSB120, HSB80, R1T, R1TC, R2T, R4H, R6L, RBG, RBP, RCP, RM70, S2, S2P, S2SH, S4, S4SH, SBG, SBP, SF10EG, SF20EG, SP12C, SP4C, SP8C		

			
1			
<b>GEV No.</b>	100906	<b>Ref. No.</b>	A1018998
<b>description</b>	screw connection thread M10x1 for ignition electrode brass Qty 1 pcs WS 10		
<b>For models:</b>	C8L, H1B, H1FV, H1L, H2B, H4H, H6H, HBG, HCP, HF20, HM100, HM150, HMI100, HMI150, HSB120, HSB80, R1T, R1TC, R4H, R6L, RBG, RBP, RCP, RM70, SBG, SBP, SF10EG, SF20EG, SP12C, SP4C, SP8C		

			
1			
<b>GEV No.</b>	100907	<b>Ref. No.</b>	A1018996
<b>description</b>	screw connection thread M10x1 Qty 1 pcs type SEF 1 ømm for thermocouple		
<b>For models:</b>	C8L, H1B, H1FV, H1L, H2B, H4H, H6H, HBG, HCP, HF20, HF40, HM100, HM150, HMI100, HMI150, HSB120, HSB80, R1T, R1TC, R4H, R6L, RBG, RBP, RCP, RM70, SBG, SBP, SF10EG, SF20EG, SP12C, SP4C, SP8C		

			
1			
<b>GEV No.</b>	100909	<b>Ref. No.</b>	A1018997
<b>description</b>	union screw thread M10x1 for pipe ø 6mm Qty 1 pcs		
<b>For models:</b>	C8L, H1B, H1FV, H1L, H2B, H4H, H6H, HBG, HCP, HF20, HF40, HM100, HM150, HMI100, HMI150, HSB120, HSB80, R1T, R1TC, R4H, R6L, RBG, RBP, RCP, RM70, SBG, SBP, SF10EG, SF20EG, SP12C, SP4C, SP8C		
<b>accessories for</b>	100909		
	<b>GEV No.</b>	100898	<b>Ref. No.</b> —
	olive for pipe ø 6mm Qty 1 pcs for pilot burner		
	<b>GEV No.</b>	101286	<b>Ref. No.</b> —
	olive ID ø 6mm Qty 1 pcs		
	<b>GEV No.</b>	101287	<b>Ref. No.</b> —
	olive for pipe ø 6mm Qty 1 pcs		
	<b>GEV No.</b>	101288	<b>Ref. No.</b> —
	olive for pipe ø 6mm L 6mm aluminium Qty 1 pcs ED ø 8.5mm		

equipment-specific units



for chicken rotisserie

skewers

			
1			
<b>GEV No.</b>	689000	<b>Ref. No.</b>	70290029
<b>description</b>	skewer square L 835mm thickness 12mm		
<b>For models:</b>	105, 105E, 1155, 1260, 1260E, 1575, 1680, 1680E, 210, 210E, 315, 315E, 420, 420E, 630, 630E, 840, 840E		

spit clamp

			
1			
<b>GEV No.</b>	693143	<b>Ref. No.</b>	702.4D.001
<b>description</b>	skewer clamp crimping range 13x13mm <sup>2</sup> double for skewer 12x12mm mounting pos. inner skewer 2x60mm skewer ø 4mm		
<b>For models:</b>	105, 105E, 10P, 1155, 1260, 1260E, 1575, 1680, 1680E, 20P, 210, 210E, 30P, 315, 315E, 40P, 420, 420E, 630, 630E, 840, 840E		

			
1			
<b>GEV No.</b>	693142	<b>Ref. No.</b>	702.45.001
<b>description</b>	skewer clamp single for skewer 12x12mm mounting pos. outer skewer 75mm skewer ø 4mm		
<b>For models:</b>	105, 105E, 1155, 1260, 1260E, 1575, 1680, 1680E, 210, 210E, 315, 315E, 420, 420E, 630, 630E, 840, 840E		
<b>accessories for</b>	693142		
	<b>GEV No.</b>	697481	<b>Ref. No.</b> —
	Thumb screw thread M6 thread L 8mm ø 14mm H 6mm SS		

knobs

producer-specific knobs

EURAST

			
1			
<b>GEV No.</b>	111414	<b>Ref. No.</b>	348273PM N/A
<b>description</b>	knob zero mark ø 71.5mm shaft ø 6x4.6mm shaft flat upper red/black		
<b>For models:</b>	105, 105E, 1155, 1260, 1260E, 1575, 1680, 1680E, 210, 210E, 315, 315E, 420, 420E, 630, 630E, 840, 840E		





			
1			
<b>GEV No.</b>	111415	<b>Ref. No.</b>	340273PM N/A
<b>description</b>	knob zero mark ø 71.5mm shaft ø 8x6.5mm shaft flat upper red/black		
<b>For models:</b>	105, 105E, 1155, 1260, 1260E, 1575, 1680, 1680E, 210, 210E, 315, 315E, 420, 420E, 630, 630E, 840, 840E		

## handles and hand wheels

### hand wheels

#### hand wheels

			
1			
<b>GEV No.</b>	694357	<b>Ref. No.</b>	C6262619
<b>description</b>	hand wheel ø 200mm D1 ø 50mm bore ø 15mm hole ø 7.2mm thread groove widthmm L1 46mm L2 50mm handle length 90mm with folding handle		
<b>For models:</b>	HSB120, HSB80		

### bracket handles



			
1			
<b>GEV No.</b>	697944	<b>Ref. No.</b>	70491019
<b>description</b>	handle L 150mm H 38mm mounting distance 135mm thread M6 W 30mm black matt		
<b>For models:</b>	105, 105E, 1155, 1260, 1260E, 1575, 1680, 1680E, 210, 210E, 315, 315E, 420, 420E, 630, 630E, 636P, 840, 840E, 848P, A4E		

## hinges



### spring assisted hinges

#### producer-specific

#### CORECO

			
1			
<b>GEV No.</b>	700830	<b>Ref. No.</b>	C6262001
<b>description</b>	spring assisted hinge right/left L 75mm W 26mm H 102mm refrigeration units mounting distance 25mm		
<b>For models:</b>	AC10G, AF02, AF04, AF04G, AF12, AM20G		
<b>accessories for</b>	700830		
	<b>GEV No.</b>	700854	<b>Ref. No.</b> —
	hinge camp type TRB/L1 36mm mounting pos. bottom right L 100mm W 48mm H 17mm zinc die cast, chrome-plated hole distance 6.5x51x28mm shaft diameter torx 12x12mmmm		

#### FAGOR

			
1			
<b>GEV No.</b>	700830	<b>Ref. No.</b>	C6262001
<b>description</b>	spring assisted hinge right/left L 75mm W 26mm H 102mm refrigeration units mounting distance 25mm		
<b>For models:</b>	AC10G, AF02, AF04, AF04G, AF12, AM20G		
<b>accessories for</b>	700830		
	<b>GEV No.</b>	700854	<b>Ref. No.</b> —
	hinge camp type TRB/L1 36mm mounting pos. bottom right L 100mm W 48mm H 17mm zinc die cast, chrome-plated hole distance 6.5x51x28mm shaft diameter torx 12x12mmmm		

oven hinges

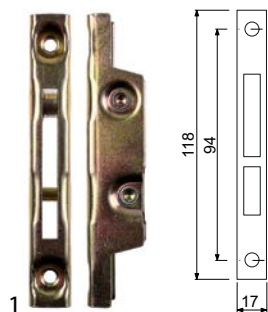

<b>GEV No.</b>	700001	<b>Ref. No.</b>	61980
<b>description</b>	opposite support L 118mm W 17mm mounting distance 94mm		
<b>For models:</b>	C8L, H1B, H1BE, H1BP, H1BPE, H1FV, H1L, H2B, H2BE, H4H, H4HE, H6H, H8HE, R4H, R6L, S3SB, S4SH, S4SHE		



<b>GEV No.</b>	694359	<b>Ref. No.</b>	6160 C6262599
<b>description</b>	oven hinge mounting distance 105mm lever length 129.5mm spring thickness 4mm mounting ear position right L 206mm W 25mm Qty 1 pcs		
<b>For models:</b>	C8L, H1B, H1BE, H1BP, H1BPE, H1FV, H1L, H2B, H2BE, H4H, H4HE, H6H, H8HE, R4H, R6L, S4SH, S4SHE		



<b>GEV No.</b>	694360	<b>Ref. No.</b>	6163 C6262609
<b>description</b>	oven hinge mounting distance 173mm mounting distance 2 105mm lug mounting 14mm lever length 119mm groove distance 11mm spring thickness 4mm mounting ear position left spring length 111mm L 206mm W 25mm		
<b>For models:</b>	C8L, H1B, H1BE, H1BP, H1BPE, H1FV, H1L, H2B, H2BE, H4H, H4HE, H6H, H8HE, R4H, R6L, S4SH, S4SHE		

door bearing



<b>GEV No.</b>	694358	<b>Ref. No.</b>	C6262002
<b>description</b>	bolt L 25mm W 25mm H 19mm ID ø 7mm for hinge		
<b>For models:</b>	AC10G, AF02, AF04, AF04G, AF12		



<b>GEV No.</b>	694361	<b>Ref. No.</b>	706203P
<b>description</b>	hinge L 100mm W 48mm mounting pos. centre left/right		
<b>For models:</b>	AC10G, AF02, AF04, AF04G, AF12		



<b>GEV No.</b>	694034	<b>Ref. No.</b>	705003P
<b>description</b>	hinge right/left mounting pos. lower for fridge L 130mm W 80mm		
<b>For models:</b>	AC10G, AF02, AF04, AF04G, AF12, AM20G		



<b>GEV No.</b>	694033	<b>Ref. No.</b>	706003P
<b>description</b>	hinge right/left mounting pos. upper for fridge L 130mm W 80mm		
<b>For models:</b>	AC10G, AF02, AF04, AF04G, AF12, AM20G		

fittings for catering equipment

lid hinges

type RUBINETTERIE DEL FRIULI

for square and rectangular lids

spare parts



<b>GEV No.</b>	540848	<b>Ref. No.</b>	C6260349
<b>description</b>	torsion spring ø 43mm wire gauge ø 5mm L1 25mm L2 90mm L3 25mm mounting pos. left		
<b>For models:</b>	HM100, HM150, HMI100, HMI150, HMI150E, HSB120, HSB80, RM70		



			
1			
<b>GEV No.</b>	540849	<b>Ref. No.</b>	C6260339
<b>description</b>	torsion spring $\phi$ 43mm wire gauge $\phi$ 5mm L1 25mm L2 90mm L3 25mm mounting pos. right		
<b>For models:</b>	HM100, HM150, HMI100, HMI150, HMI150E, HSB120, HSB80, RM70		

miscellaneous  
spare parts

			
1			
<b>GEV No.</b>	514418	<b>Ref. No.</b>	C6260239
<b>description</b>	adjusting bush ID $\phi$ 47mm ED $\phi$ 50mm L 63.5mm		
<b>For models:</b>	HM100, HM150, HMI100, HMI150, HMI150E, HSB120, HSB80, RM70		

			
1			
<b>GEV No.</b>	514194	<b>Ref. No.</b>	481240P
<b>description</b>	bracket for lid hinge ID $\phi$ 50mm H 89mm		
<b>For models:</b>	HSB120, HSB80		

			
1			
<b>GEV No.</b>	514193	<b>Ref. No.</b>	480340P
<b>description</b>	bracket for lid hinge ID $\phi$ 51mm H 185mm		
<b>For models:</b>	HM100, HM150, HMI100, HMI150, HMI150E, RM70		

**gaskets**

refrigeration gaskets

plug-in gaskets

profile 9798

We offer custom-made gaskets for this profile

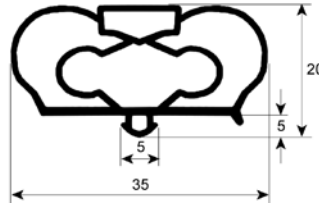
			
1			
<b>GEV No.</b>	901349	<b>Ref. No.</b>	705226P
<b>description</b>	refrigeration gasket profile 9798 W 602mm L 704mm plug size		
<b>For models:</b>	AC10G, AF02, AF04, AF04G, AF12		

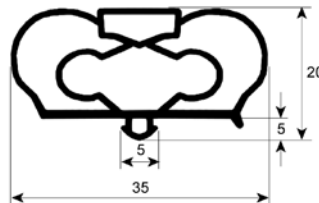
			
1			
<b>GEV No.</b>	901350	<b>Ref. No.</b>	746226P
<b>description</b>	refrigeration gasket profile 9798 W 604mm L 1492mm plug size		
<b>For models:</b>	AC10G, AF12, AM20G		

**gaskets for heated units**

door seals

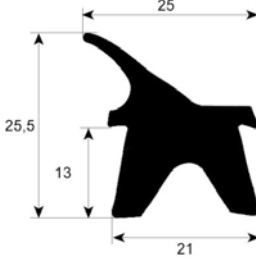
			
1			
<b>GEV No.</b>	901347	<b>Ref. No.</b>	490326P
<b>description</b>	door seal profile 2402 W 350mm L 575mm external size Qty 1		
<b>For models:</b>	H1B, H1BE, H1BP, H1BPE, H1FV, H2B, H2BE, H4H, H4HE, H6H, H8HE, R4H, S3SB, S4SH, S4SHE		

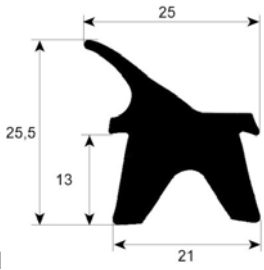

1

<b>GEV No.</b>	901348	<b>Ref. No.</b>	499926P
<b>description</b>	door seal profile 2402 W 350mm L 985mm external size Qty 1		
<b>For models:</b>	H1L, H6H, R6L		

### O-rings

#### EPDM

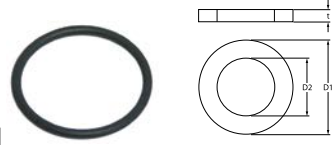

1

<b>GEV No.</b>	100809	<b>Ref. No.</b>	3785
<b>description</b>	O-ring EPDM thickness 2mm ID ø 21mm Qty 1 pcs		
<b>For models:</b>	H1B, H1FV, H1L, H2B, H4H, H6H, HF20, HF40, HSB120, HSB80, R1T, R1TC, R4H, R6L, SF10EG, SF20EG, SP12C, SP4C, SP8C		

### springs

#### torsion springs



1

<b>GEV No.</b>	540848	<b>Ref. No.</b>	C6260349
<b>description</b>	torsion spring ø 43mm wire gauge ø 5mm L1 25mm L2 90mm L3 25mm mounting pos. left		
<b>For models:</b>	HM100, HM150, HMI100, HMI150, HMI150E, HSB120, HSB80, RM70		



1

<b>GEV No.</b>	540849	<b>Ref. No.</b>	C6260339
<b>description</b>	torsion spring ø 43mm wire gauge ø 5mm L1 25mm L2 90mm L3 25mm mounting pos. right		
<b>For models:</b>	HM100, HM150, HMI100, HMI150, HMI150E, HSB120, HSB80, RM70		

## fastening material

### screws

#### flat-headed bolts



1

<b>GEV No.</b>	101516	<b>Ref. No.</b>	1051
<b>description</b>	flat-headed bolt thread M4 thread L 16mm SS DIN 7985/ISO 7045 Qty 1 pcs		
<b>For models:</b>	H1B, H1FV, H1L, H2B, H4H, H6H, HF20, HF40, HSB120, HSB80, R1T, R1TC, R4H, R6L, SF10EG, SF20EG, SP12C, SP4C, SP8C		

### nuts

#### hexagonal nuts

#### hexagonal nuts metric (without norm)



1

<b>GEV No.</b>	102680	<b>Ref. No.</b>	C5815299
<b>description</b>	nut thread M6x0.75 H 2.6mm WS 8 brass Qty 1 pcs type SEF 2		
<b>For models:</b>	C8L, H4H, H6H, R2T, R4H, R6L		



1

<b>GEV No.</b>	102067	<b>Ref. No.</b>	C5811029
<b>description</b>	nut thread M8x1 H 3mm brass Qty 1 pcs type SEF 1		
<b>For models:</b>	105, 105E, 1155, 1260, 1260E, 1575, 1680, 1680E, 210, 210E, 315, 315E, 420, 420E, 630, 630E, 636P, 840, 840E, 848P, FOK30, FOK60, FOK90, PC100, PC100C, PC100F, PC60, PC60C, PC60F, PC80, PC80C, PC80F, S3SB		

<b>C</b>			
cam switches	6		
capillary tube clips	5		
ceramic burners	14		
ceramic heaters	3		
coil heating elements	3		
contactors	7		
control thermostats	5, 5		
<b>D</b>			
door seals	19		
<b>E</b>			
electronic controllers	7		
energy regulators	4		
<b>F</b>			
fastening material	20		
flat-headed bolts	20		
foil heating elements	4		
<b>G</b>			
gas burners	13		
gas control valves	9		
gas nozzles	14		
gas taps	7		
gas thermostats	9		
gaskets for heated units	19		
<b>H</b>			
heating elements	3		
heating elements for fryers	3		
heating elements for ovens	3		
hexagonal nuts	20		
hob burners	13		
hot plates	4		
<b>I</b>			
ignition cables	11		
indicator lights	6		
indicator lights (complete)	6		
<b>L</b>			
lamps	6		
<b>M</b>			
motors	7		
<b>N</b>			
nuts	20		
<b>O</b>			
O-rings	20		
oven hinges	18		
oven lamps	6		
<b>P</b>			
piezoelectric igniters	11		
pilot burners	9		
plug-in gaskets	19		
<b>R</b>			
radiation heaters	4		
refrigeration gaskets	19		
rocker/momentary rocker switches	6		
<b>S</b>			
safety thermostats	5		
screws	20		
spring assisted hinges	17		
switches and momentary switches	6		
<b>T</b>			
thermocouples	11		
thermostats	5		
tube burners	14		