



GAS COMPONENTS



ELECTRIC COMPONENTS



WATER TECHNOLOGY



MECHANICAL COMPONENTS



TOOLS

Spare parts suitable for

FORVED

Find the complete and up-to-date range of products in our GEV Webshop



Manufacturer catalogue

The most important spare parts and accessories arranged clearly for every manufacturer

- ✓ Complete product range and all appliance data always up to date in the GEV Webshop
- ✓ Alphabetical Index at the end of the catalogue

GEV Webshop

www.gev-online.co.uk

www.gev-online.com



- 🔍 Add to Favourites
- 🔍 Sign In with email address and usual password
- 🔍 Easy-order – place several items in your basket at the same time
- 🔍 Quick Item search – no login needed



heating elements

heating elements for bain maries

1	
GEV No.	416887
Ref. No.	SNACKRESIS01
description	heating element 1350W 230V heating circuits 1 L 385mm W 225mm connection male faston 6.3mm connection distance 110mm tube ø 8.5mm dry heating element W1 50mm W2 125mm H 22mm

1	
GEV No.	416884
Ref. No.	VETRRES02 VETRRES03
description	heating element 700W 230V heating circuits 1 L 500mm W 270mm connection male faston 6.3mm connection distance 257mm connection length 20mm tube ø 6.3mm dry heating element

heating elements for fryers

2 hole fixing

1	
GEV No.	416891
Ref. No.	3108
description	heating element 3000W 230V heating circuits 1 L 362mm W 65mm H 240mm L1 57mm L2 305mm H1 192mm H2 48mm thread 1/4" tube ø 8.5mm 2 hole fixing connection M5 fryer heaters windings 4

spare parts for	416891
	GEV No. 510417 Ref. No. — flat gasket fibre ED ø 20mm ID ø 14mm thickness 2mm Qty 1 pcs
accessories for	416891
	GEV No. 501318 Ref. No. — nut thread 1/4" H 6.5mm SS WS 22 Qty 1 pcs
	GEV No. 503045 Ref. No. — nut thread 1/4" H 4.5mm brass WS 17 Qty 1 pcs
	GEV No. 560112 Ref. No. — plain washer ID ø 5.3mm ED ø 10mm thickness 1mm SS Qty 20 pcs DIN 125A for thread M5
	GEV No. 560132 Ref. No. — hexagonal nut thread M5 H 4mm WS 8 SS DIN/ISO DIN 934 / ISO 4032/8673 Qty 20 pcs

1	
GEV No.	416892
Ref. No.	3108A
description	heating element 4000W 230V heating circuits 1 L 347mm W 85mm H 235mm L1 47mm L2 300mm H1 195mm H2 40mm thread 1/4" mounting distance 77mm tube ø 8.5mm 2 hole fixing connection M5 fryer heaters windings 4



accessories for	416892
	GEV No. 361182 Ref. No. — nut thread 1/4" H 5mm nickel-plated brass WS 17 Qty 1 pcs
	GEV No. 510417 Ref. No. — flat gasket fibre ED ø 20mm ID ø 14mm thickness 2mm Qty 1 pcs
	GEV No. 520228 Ref. No. — tooth lock washer ID ø 15.3mm ED ø 24mm steel Qty 1 pcs for thread M14
	GEV No. 550262 Ref. No. — flat gasket copper ED ø 20mm ID ø 14mm thickness 2mm
	GEV No. 560112 Ref. No. — plain washer ID ø 5.3mm ED ø 10mm thickness 1mm SS Qty 20 pcs DIN 125A for thread M5
	GEV No. 560132 Ref. No. — hexagonal nut thread M5 H 4mm WS 8 SS DIN/ISO DIN 934 / ISO 4032/8673 Qty 20 pcs

1	
GEV No.	416890
Ref. No.	3111
description	heating element 1670W 230V heating circuits 1 L 360mm W 85mm H 233mm L1 60mm L2 300mm H1 200mm H2 48mm thread 1/4" mounting distance 77mm tube ø 8.5mm 2 hole fixing connection M5 connection length 25mm fryer heaters windings 3

accessories for	416890
	GEV No. 361182 Ref. No. — nut thread 1/4" H 5mm nickel-plated brass WS 17 Qty 1 pcs
	GEV No. 510417 Ref. No. — flat gasket fibre ED ø 20mm ID ø 14mm thickness 2mm Qty 1 pcs
	GEV No. 520228 Ref. No. — tooth lock washer ID ø 15.3mm ED ø 24mm steel Qty 1 pcs for thread M14
	GEV No. 550262 Ref. No. — flat gasket copper ED ø 20mm ID ø 14mm thickness 2mm





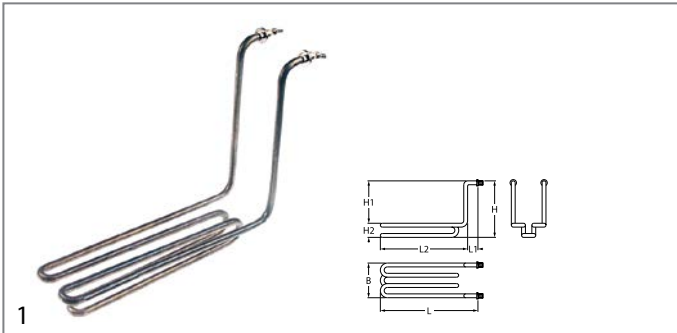

Table continues overleaf



accessories for 416890			
	GEV No.	560112	Ref. No. —
plain washer ID ϕ 5.3mm ED ϕ 10mm thickness 1mm SS Qty 20 pcs DIN 125A for thread M5			
	GEV No.	560132	Ref. No. —
hexagonal nut thread M5 H 4mm WS 8 SS DIN/ISO DIN 934 / ISO 4032/8673 Qty 20 pcs			



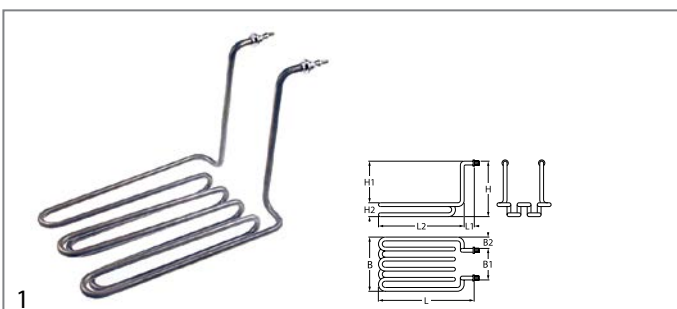

GEV No.	416889	Ref. No.	3966
description	heating element 2000W 230V heating circuits 1 L 310mm W 73mm H 225mm L1 40mm L2 270mm H1 190mm H2 36mm thread 1/4" mounting distance 65mm tube ϕ 8.5mm 2 hole fixing connection M5 fryer heaters windings 3		

accessories for 416889			
	GEV No.	361182	Ref. No. —
nut thread 1/4" H 5mm nickel-plated brass WS 17 Qty 1 pcs			
	GEV No.	510417	Ref. No. —
flat gasket fibre ED ϕ 20mm ID ϕ 14mm thickness 2mm Qty 1 pcs			
	GEV No.	520228	Ref. No. —
tooth lock washer ID ϕ 15.3mm ED ϕ 24mm steel Qty 1 pcs for thread M14			
	GEV No.	550262	Ref. No. —
flat gasket copper ED ϕ 20mm ID ϕ 14mm thickness 2mm			
	GEV No.	560112	Ref. No. —
plain washer ID ϕ 5.3mm ED ϕ 10mm thickness 1mm SS Qty 20 pcs DIN 125A for thread M5			
	GEV No.	560132	Ref. No. —
hexagonal nut thread M5 H 4mm WS 8 SS DIN/ISO DIN 934 / ISO 4032/8673 Qty 20 pcs			



GEV No.	416888	Ref. No.	3955
description	heating element 3500W 230V heating circuits 2 L 300mm W 115mm H 232mm L1 28mm L2 272mm H1 190mm H2 42mm thread 1/4" tube ϕ 8.5mm 2 hole fixing connection M5 immersion heater windings 5 W1 70mm W2 45mm		

accessories for 416888			
	GEV No.	560112	Ref. No. —
plain washer ID ϕ 5.3mm ED ϕ 10mm thickness 1mm SS Qty 20 pcs DIN 125A for thread M5			

accessories for 416888			
	GEV No.	560132	Ref. No. —
hexagonal nut thread M5 H 4mm WS 8 SS DIN/ISO DIN 934 / ISO 4032/8673 Qty 20 pcs			

heating elements for hot counters



GEV No.	416883	Ref. No.	VETRRESSCB80
description	heating element 230V		

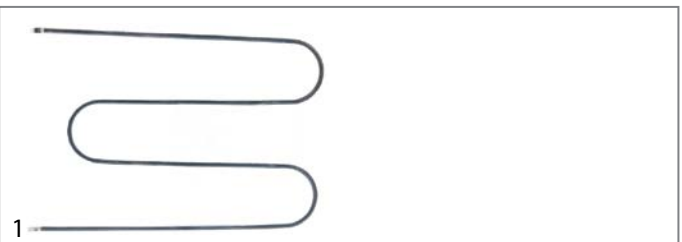

GEV No.	416881	Ref. No.	VETRRES01
description	heating element 400W 230V heating circuits 1 L 400mm W 280mm tube ϕ 6.3mm connection male faston 6.3mm dry heating element for vitrine		

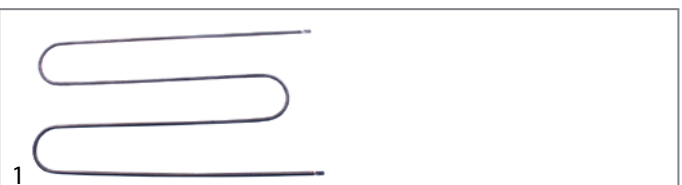

GEV No.	416882	Ref. No.	VETRRES02
description	heating element 500W 230V heating circuits 1 L 500mm W 275mm connection distance 268mm tube ϕ 6.3mm connection male faston 6.3mm dry heating element for vitrine		

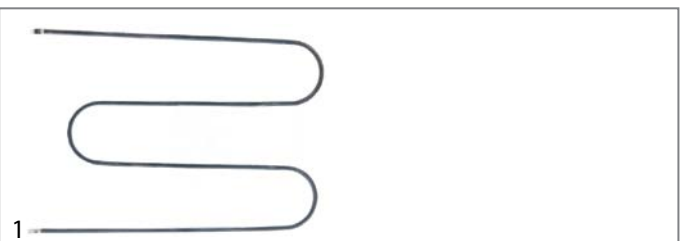

GEV No.	419010	Ref. No.	VETRRES01
description	heating element 600W 230V heating circuits 1 L 400mm W 280mm tube ϕ 6.3mm connection male faston 6.3mm dry heating element for vitrine		

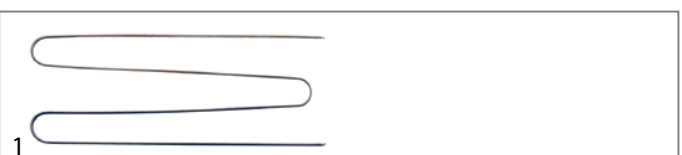

GEV No.	418791	Ref. No.	VETRRES03
description	heating element 900W 230V heating circuits 1 L 615mm W 265mm tube ϕ 6.3mm connection male faston 6.3mm dry heating element		





GEV No.	416885	Ref. No.	VETRRES04
description	heating element 900W 230V heating circuits 1 L 870mm W 345mm connection distance 339mm connection length 20mm tube ø 6.3mm connection male faston 6.3mm dry heating element		

heating elements for contact grills



GEV No.	416877	Ref. No.	GRILLRES02
description	heating element 1000W 230V L 180mm W 192mm H 18mm L1 5mm L2 175mm W1 53mm W2 86mm tube ø 8.5mm mounting pos. upper connection M5 windings 3 dry heating element		



GEV No.	416879	Ref. No.	GRILLRES03
description	heating element 1200W 230V L 177mm W 257mm H 18mm L1 8mm L2 160mm W1 73mm W2 111mm tube ø 8.5mm connection length 24mm mounting pos. upper connection M4 windings 4 dry heating element		



GEV No.	416878	Ref. No.	GRILLRES01
description	heating element 1400W 230V L 198mm W 220mm H 46mm W1 60mm W2 100mm tube ø 8.5mm connection M5 connection length 24mm mounting pos. lower dry heating element windings 4		



GEV No.	416880	Ref. No.	GRILLRES04
description	heating element 1700W 230V L 198mm W 278mm H 40mm W1 60mm W2 168mm tube ø 8.5mm connection M4 connection length 23mm mounting pos. lower dry heating element windings 5		

heating elements for salamanders/toast-



GEV No.	416874	Ref. No.	TOSTRES01
description	heating element 450W 115V L 344mm thread M12x1 connection length 23mm tube ø 8.5mm connection male faston 6.3mm heating circuits 1 dry heating element toaster W 8.5mm H 8.5mm		

quartz heating elements



GEV No.	416187	Ref. No.	TOSTRES01
description	quartz heating element 400W 115V L 260mm ø 12mm connection male faston 6.3mm mounting distance 24.8mm		



GEV No.	418625	Ref. No.	TOSTRES02
description	quartz heating element 500W 115V L 365mm ø 10mm connection male faston 6.3mm		



GEV No.	416873	Ref. No.	TOSTRES04
description	quartz heating element 500W 75V L 510mm ø 12mm connection male faston 6.3mm mounting distance 495mm 110ohm		



GEV No.	416871	Ref. No.	TOSTRES01
description	quartz heating element 800W 230V L 285mm		



hot plates

round

with radiused edge

for domestic and commercial kitchens



1

GEV No.	490129	Ref. No.	SNACKPIAS1
description	hot plate ø 180mm 1500W 230V connection 4 screw clamps with 8mm spill ring		



1

GEV No.	490130	Ref. No.	SNACKPIAS2
description	hot plate ø 220mm 2000W 230V connection 4 screw clamps with 8mm spill ring		

thermostats

bi-metal thermostats

bi-metal thermostats



1

GEV No.	390323	Ref. No.	VETRTERMSICU
description	bi-metal thermostat hole distancemm switch-off temp. 145°C 1NC 1-pole 16A connection F6.3 M4		

control and safety thermostats

EGO

control thermostats

55.10/19_ series

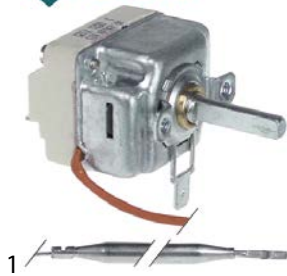

1

GEV No.	375777	Ref. No.	3064
description	thermostat t.max. 180°C temperature range 70-180°C 1-pole 1NO 16A probe ø 6mm probe L 87mm capillary pipe 600mm capillary pipe isolated 350mm gland nut shaft ø 6x4.6mm shaft L 23mm shaft position upper rotation 270°		



1

GEV No.	375002	Ref. No.	GRILLTERMOS
description	thermostat t.max. 320°C temperature range 55-320°C 1-pole 1NO 16A probe ø 3.1mm probe L 226mm capillary pipe 870mm capillary pipe isolated 850mm gland nut shaft L 23mm shaft position upper rotation 270°		

safety thermostats

55.32_ series



1

GEV No.	375724	Ref. No.	03299/A
description	safety thermostat switch-off temp. 246°C 3-pole 20A probe ø 6mm probe L 79mm capillary pipe 1300mm capillary pipe isolated 1100mm gland nut probe SS		

IMIT / TEMPOMATIC / ARTERMO

control thermostats



1

GEV No.	375620	Ref. No.	VETRTER120
description	thermostat t.max. 120°C temperature range 30-120°C 1-pole 1CO 15A probe ø 6.5mm probe L 95mm capillary pipe 1000mm capillary pipe isolated 1000mm gland nut shaft ø 6x4.6mm shaft L 19mm shaft position upper rotation 270°		

1

GEV No.	375543	Ref. No.	3064
description	thermostat t.max. 190°C 1-pole gland nut shaft ø 6x4.6mm		

safety thermostats



1

GEV No.	375542	Ref. No.	9004
description	safety thermostat LS1 8174 switch-off temp. 238°C 1-pole 15A probe ø 5mm probe L 100mm capillary pipe 550mm capillary pipe isolated-mm gland nut probe SS		



1

GEV No.	375509	Ref. No.	9004
description	thermostat switch-off temp. 230°C 1-pole 1NC 16A probe ø 6mm probe L 62mm capillary pipe 450mm capillary pipe isolated 40mm gland nut probe screw connection M10x1 connection male faston 6.3mm		

CAMPINI safety thermostats



1

GEV No.	375915	Ref. No.	9004
description	safety thermostat switch-off temp. 232°C 1-pole 1NC 16A probe ø 5mm probe L 68mm capillary pipe 960mm capillary pipe isolated 70mm screw connection M10		

various control thermostats



1

GEV No.	375820	Ref. No.	3064
description	thermostat t.max. 190°C temperature range 0-190°C 1-pole 1CO 16A probe ø 4.5mm probe L 130mm capillary pipe 550mm shaft ø 6x4.6mm shaft L 19mm shaft position upper rotation 270° 250V		

switches and momentary switches rocker/momentary rocker switches

30x22mm



1

GEV No.	301003	Ref. No.	TOSTINTER
description	rocker switch mounting measurements 30x22mm green 2NO 250V 16A illuminated 0-I connection male faston 6.3mm ambient temperature max. 125/55°C protection IP65		
accessories for	301003		
	GEV No.	301036	Ref. No. —
	protective cover internal size 30x22mm for rocker switch mounting measurementsmm		

microswitches lever actuated



1

GEV No.	345255	Ref. No.	03041/A
description	microswitch with lever 250V 16A 1CO connection male faston 6.3mm L 35mm L1 28mm ambient temperature max. 125°C mounting distance 22mm actuating force: 136g lever length 27mm		



1

GEV No.	347684	Ref. No.	03041/B
description	microswitch with lever 250V 16A 2NO connection male faston 6.3mm L 36mm ambient temperature max. 125°C mounting distance 22.2mm type VRSR01AA1 actuating force: 145g		



cam switches

on/off

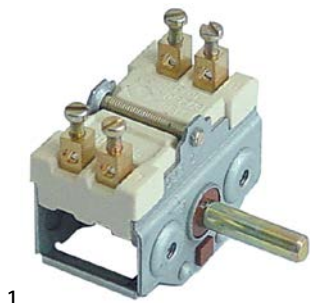

1

GEV No.	300151	Ref. No.	03227/B
----------------	--------	-----------------	---------

description	cam switch 2 operating positions 2NO sequence 0-1 16A shaft ø 6x4.6mm shaft L 23mm connection screw ceramic		
--------------------	---	--	--



1

GEV No.	300176	Ref. No.	03227/A
----------------	--------	-----------------	---------

description	cam switch 2 operating positions 4NO sequence 0-1 16A shaft ø 6x4.6mm shaft L 23mm connection screw		
--------------------	---	--	--

7-position



1

GEV No.	300177	Ref. No.	SNACKCOMMUT
----------------	--------	-----------------	-------------

description	cam switch 7 operating positions 6NO sequence 0-1-2-3-4-5-6 16A shaft ø 6x4.6mm shaft L 23mm connection male faston 6.3mm 7-position		
--------------------	--	--	--

lamps

indicator lights

indicator lights 2-piece (lens and indicator lamp)

indicator light lenses

ø10mm (type SR-3)



1

GEV No.	359815	Ref. No.	3066
----------------	--------	-----------------	------

description	indicator light housings mounting measurements ø10mm clear Qty 1 pcs		
--------------------	--	--	--



1

GEV No.	359816	Ref. No.	3067
----------------	--------	-----------------	------

description	indicator light housings mounting measurements ø10mm green Qty 1 pcs		
--------------------	--	--	--

indicator lamps for socket type SA / SC / SD / SF / SR



1

GEV No.	359814	Ref. No.	3676
----------------	--------	-----------------	------

description	indicator lamp 230V clear connection cable 400mm cable material silicone Qty 1 pcs		
--------------------	--	--	--

indicator lights (complete)

ø10mm

with plug-in socket



1

GEV No.	359374	Ref. No.	TOSTGEMMA
----------------	--------	-----------------	-----------

description	indicator light ø 10mm 230V green		
--------------------	-----------------------------------	--	--

ø13mm

with plug-in socket



1

GEV No.	359142	Ref. No.	GRILLAMPAD
----------------	--------	-----------------	------------

description	indicator light ø 13mm green 230V connection male faston 6.3mm temp.-resist. 120°C Qty 1 pcs		
--------------------	--	--	--



1

GEV No.	359143	Ref. No.	GRILLAMPAD GRILLGEMMA TOSTLAMP VETRIGEMMA
----------------	--------	-----------------	--

description	indicator light ø 13mm yellow 230V connection male faston 6.3mm temp.-resist. 120°C Qty 1 pcs		
--------------------	---	--	--



timers

mechanical timers

 <p>1</p>			
GEV No.	350032	Ref. No.	Tosttimer
description	timer M2 2-pole operation time 15min impulse mechanical 2NO at 250V 16A permanent position no shaft ø 6x4.6mm shaft L 18mm mounting distance 28mm connection rear		
accessories for	350032		
	GEV No.	110366	Ref. No. Tosttimerman
	knob switch zero mark t.max.°C ø 44mm shaft ø 6x4.6mm shaft flat upper black		
	GEV No.	110371	Ref. No. —
	dial plate graduation 15min permanent position no rotation 30-330° ø 60mm timers knob ø 45mm		

spare parts and accessories

knobs

 <p>1</p>			
GEV No.	110366	Ref. No.	Tosttimerman
description	knob switch zero mark t.max.°C ø 44mm shaft ø 6x4.6mm shaft flat upper black		

contactors



GENERAL ELECTRIC (AEG)

power contactors

 <p>1</p>			
GEV No.	380238	Ref. No.	9023 SALAMANDCONT
description	power contactor resistive load 20A 230VAC (AC3/400V) 8.4A/4kW main contacts 3NO auxiliary contacts 1NO connection screw connection type LS0510A type AEG LS0510A type GE MC1A 310A		

ignition parts

pilot burners

SIT			
100 series			
 <p>1</p>			
GEV No.	107139	Ref. No.	03139
description	pilot burner SIT type 100 series 1 flame nozzle ø 0.2mm gas connectionmm		
spare parts for	107139		
	GEV No.	100854	Ref. No. —
	pilot burner bracket double		
	GEV No.	100885	Ref. No. —
	air mixing sleeve for pilot burner Qty 1 pcs		
	GEV No.	107160	Ref. No. —
	pilot burner cap SIT 1 flame Hmm Lmm Qty 1 pcs		
accessories for	107139		
	GEV No.	100904	Ref. No. —
	locking screw M10x1 for pipe ø 4mm Qty 1 pcs		
	GEV No.	100905	Ref. No. —
	locking screw M10x1 for pipe ø 6mm Qty 1 pcs		
	GEV No.	100998	Ref. No. —
	pilot burner bottom part nozzle ø 0.21mm suitable for 100 series		
	GEV No.	102110	Ref. No. —
	pilot tube copper pipe ø 4mm thickness 1mm L 3000mm		
	GEV No.	102111	Ref. No. —
	pilot tube copper pipe ø 6mm thickness 1mm L 3000mm		

accessories

ignition electrodes

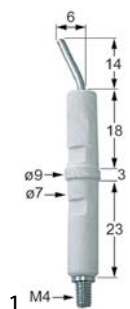

GEV No.	100706	Ref. No.	3152
description	ignition electrode connection M4 Qty 1 pcs		

electrodes

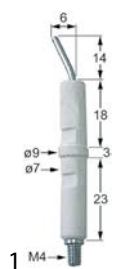

GEV No.	100706	Ref. No.	3152
description	ignition electrode connection M4 Qty 1 pcs		

gas nozzles

main nozzles

gas nozzles M12x1



GEV No.	106568	Ref. No.	FRIGUGELLI
description	gas injector thread M12x1 WS 13 bore ø 1.25mm		

equipment-specific units

for toasters

pliers

pliers



GEV No.	690010	Ref. No.	TOSTPINZA
description	plier for toaster H 180mm total length 100mm		

knobs

producer-specific knobs

FORVED



GEV No.	112011	Ref. No.	3096
description	knob switch zero mark ø 41mm shaft ø 6x4.6mm shaft flat upper black		



GEV No.	111550	Ref. No.	SNACKMANCUC VETREMANTERM
description	knob switch zero mark ø 48mm shaft ø 6x4.6mm shaft flat upper black		

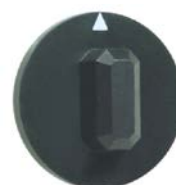

GEV No.	110366	Ref. No.	Tosttimerman
description	knob switch zero mark t.max. °C ø 44mm shaft ø 6x4.6mm shaft flat upper black		



handles and hand wheels

handle bars

handle bars



GEV No. 693200 **Ref. No.** GRILLIMPEGNO

description handle rod

bracket handles



GEV No. 693440 **Ref. No.** 3063

description pull handle mounting distance 88mm for fryer

For models: FLT 8+8BS, FLT 8BS, FLT12+12B, FLT12+12BS, FLT12B, FLT12BS, FLT20+20B, FLT20+20BS, FLT20B, FLT20BS

hinges

oven hinges

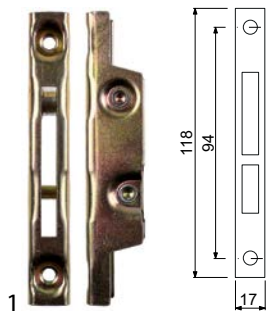

GEV No. 700001 **Ref. No.** 03808c

description opposite support L 118mm W 17mm mounting distance 94mm



GEV No. 700006 **Ref. No.** 03478D

description oven hinge mounting distance 173mm mounting distance 2 105mm lug mounting 14mm lever length 120mm groove distance 11mm spring thickness 3.5mm mounting ear position left spring length 112mm W 25mm

accessories for 700006



GEV No. 700001 **Ref. No.** 03808c

opposite support L 118mm W 17mm mounting distance 94mm

accessories for 700006



GEV No. 700007 **Ref. No.** 03478s

oven hinge mounting distance 173mm mounting distance 2 105mm lug mounting 14mm lever length 120mm groove distance 11mm spring thickness 3.5mm mounting ear position right spring length 112mm W 25mm

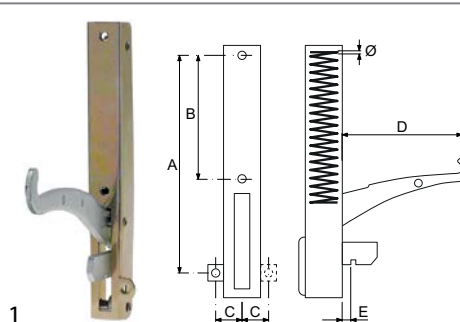

GEV No. 700007 **Ref. No.** 03478s

description oven hinge mounting distance 173mm mounting distance 2 105mm lug mounting 14mm lever length 120mm groove distance 11mm spring thickness 3.5mm mounting ear position right spring length 112mm W 25mm

accessories for 700007



GEV No. 700001 **Ref. No.** 03808c

opposite support L 118mm W 17mm mounting distance 94mm



GEV No. 700006 **Ref. No.** 03478D

oven hinge mounting distance 173mm mounting distance 2 105mm lug mounting 14mm lever length 120mm groove distance 11mm spring thickness 3.5mm mounting ear position left spring length 112mm W 25mm

fittings for catering equipment

outlet taps

universal

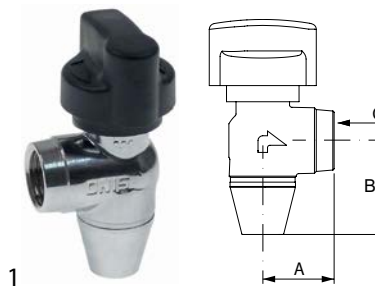

GEV No. 540747 **Ref. No.** FRIGRUBINFR8

description outlet tap chrome-plated brass angled W 30mm H 40mm thread 1/2" IT

producer-specific

FORVED



1

GEV No.	514006	Ref. No.	3962
description	drain pipe L 200mm thread ø 22mm		



1

GEV No.	540952	Ref. No.	3964
description	outlet tap L 84mm fryer lever handle grommet ø 30mm grommet length 29mm thread 3/4" IT handle length 81mm		



1

GEV No.	970701	Ref. No.	3961
description	fryer basket W1 220mm L1 280mm H1 110mm H2 200mm		



1

GEV No.	970374	Ref. No.	3961
description	fryer basket W1 235mm L1 270mm H1 110mm H2 210mm chrome-plated steel		

baskets

fryer baskets

FORVED



1

GEV No.	970372	Ref. No.	3960
description	fryer basket W1 190mm L1 245mm H1 110mm L2 450mm H2 225mm		



1

GEV No.	970373	Ref. No.	3967
description	fryer basket W1 210mm L1 250mm H1 110mm		



1

GEV No.	970004	Ref. No.	100117
description	fryer basket W1 313mm L1 490mm H1 115mm		



1

GEV No.	970376	Ref. No.	3323
description	fryer basket W1 337mm L1 606mm H1 115mm		

springs

torsion springs



1

GEV No.	693199	Ref. No.	GRILLMOLLA
description	torsion spring ø 21mm L1 38mm L2 118mm L3 38mm wire gauge ø 3.8mm		



valves and tank inlets

ball valves

universal

ball valves with lever handle



GEV No.	540910	Ref. No.	3118
description	ball valve connection 3/4" IT - hose ø19mm total length 110mm with lever handle handle length 95mm		

B

ball valves	13
bi-metal thermostats	6, 6

C

cam switches	8
contactors	9
control thermostats	6, 6

G

gas nozzles	10
-------------	----

H

heating elements	3
heating elements for bain maries	3
heating elements for contact grills	5
heating elements for fryers	3
heating elements for salamanders/toasters	5
hot plates	6

I

indicator lights	8
indicator lights (complete)	8

L

lamps	8
-------	---

M

mechanical timers	9
microswitches	7

O

oven hinges	11
-------------	----

P

pilot burners	9
---------------	---

Q

quartz heating elements	5
-------------------------	---

R

rocker/momentary rocker switches	7
----------------------------------	---

S

safety thermostats	6, 7
switches and momentary switches	7

T

thermostats	6
timers	9

V

valves and tank inlets	13
------------------------	----