



GAS COMPONENTS



ELECTRIC COMPONENTS



WATER TECHNOLOGY



MECHANICAL COMPONENTS



TOOLS

Spare parts suitable for

KASTEL

Find the complete and up-to-date range of products in our GEV Webshop



Manufacturer catalogue

The most important spare parts and accessories arranged clearly for every manufacturer

- ✓ Complete product range and all appliance data always up to date in the GEV Webshop
- ✓ Alphabetical Index at the end of the catalogue

GEV Webshop

www.gev-online.co.uk

www.gev-online.com



- 🔍 Add to Favourites
- 🔍 Sign In with email address and usual password
- 🔍 Easy-order – place several items in your basket at the same time
- 🔍 Quick Item search – no login needed



thermostats

bi-metal thermostats

safety bi-metal thermostats



GEV No. 390578 **Ref. No.** K00076

description bi-metal safety thermostat hole distance 25mm 1NC 1-pole

refrigeration thermostats

RANCO

K22 series

RANCO



GEV No. 390579 **Ref. No.** K00080 (old version)

description thermostat RANCO type K22L1081 probe \varnothing 2mm probe Lmm capillary pipe 2250mm

K50 series

RANCO



GEV No. 390286 **Ref. No.** K00079

description thermostat RANCO type K50L3383 probe \varnothing mm probe Lmm capillary pipe 1500mm temperature range +1 up to +3°C

miscellaneous producers



GEV No. 390996 **Ref. No.** K00080

description thermostat probe \varnothing 2mm probe Lmm capillary pipe 2250mm type K22L1081

switches and momentary switches

microswitches

lever actuated



GEV No. 346872 **Ref. No.** 601003

description microswitch with lever 250V 0.1A 1CO connection male faston 6.3mm L 50mm ambient temperature max. 85°C mounting distance 22mm type D41X actuating force: 6g lever length 36mm

float switches

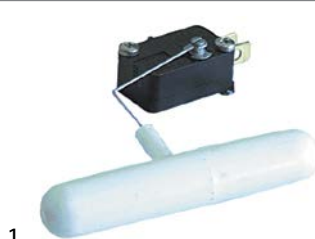

GEV No. 345372 **Ref. No.** 601043

description float switch 1CO \varnothing 15mm L 104mm 250V 6A male faston 6.3mm cable lengthmm



GEV No. 345371 **Ref. No.** 601082

description float switch with plunger 250V 16A 1CO male faston 6.3mm L 60mm ambient temperature max. 125°C mounting distance 22mm type EF83161.5 actuating force: 20g blue/black

timers

programme timers





GEV No. 360368 **Ref. No.** K00257

description timer CDC 11904 engines 1 chambers 4 operation time 10min 230V manuf. no. 11904F1 / K00257 motor type M48R ATS

spare parts for 360368



GEV No. 360118 **Ref. No.** —
description motor CDC pinion \varnothing 4.9mm teeth 10 230V voltage AC 50/60Hz turn direction right motor \varnothing 47mm H 19.3mm motor type M48R ATS for timer cable length 260mm 1.9/2.5W

			
1			
GEV No.	360367	Ref. No.	K00075
description	timer CDC 11904 engines 1 chambers 4 operation time 12min 230V shaft ømm shaft Lmm manif. no. 11904F1 / K00075 motor type M48R ATS		
spare parts for	360367		
	GEV No.	360118	Ref. No. —
	motor CDC pinion ø 4.9mm teeth 10 230V voltage AC 50/60Hz turn direction right motor ø 47mm H 19.3mm motor type M48R ATS for timer cable length 260mm 1.9/2.5W		

contactors

LOVATO

power contactors

			
1			
GEV No.	380964	Ref. No.	00005140
description	power contactor resistive load 20A 230VAC (AC3/400V) 9A/4kW main contacts 4NO auxiliary contacts connection screw connection type 11BG09T4A230		

probes

producer-specific probes

probes

			
1			
GEV No.	379851	Ref. No.	K04678
description	temperature probe NTC 10kOhm cable silicone probe -40 up to +110°C cable -50 up to +180°C connection plug thread probe ø6x-50mm cable length 1.5m		

			
1			
GEV No.	403223	Ref. No.	K04677
description	temperature probe NTC 10kOhm cable silicone probe -40 up to +110°C cable -50 up to +180°C connection plug thread probe ø6x-50mm cable length 2m		



			
1			
GEV No.	401892	Ref. No.	K01473
description	temperature probe NTC 10kOhm cable TPE probe -40 up to +110°C cable -40 up to +110°C connection plug thread probe ø6x14mm cable length 1.5m		

			
1			
GEV No.	401891	Ref. No.	K01472
description	temperature probe NTC 10kOhm cable TPE probe -40 up to +110°C cable -40 up to +110°C connection plug thread probe ø6x14mm cable length 2m		

electronics

PCBs

			
1			
GEV No.	401890	Ref. No.	K01471 K04601
description	PCB		

			
1			
GEV No.	403100	Ref. No.	K04720
description	PCB ice maker KP 75 L 115mm W 95mm 230V		
accessories for	403100		
	GEV No.	379851	Ref. No. K04678
	temperature probe NTC 10kOhm cable silicone probe -40 up to +110°C cable -50 up to +180°C connection plug thread probe ø6x-50mm cable length 1.5m		
	GEV No.	403223	Ref. No. K04677
	temperature probe NTC 10kOhm cable silicone probe -40 up to +110°C cable -50 up to +180°C connection plug thread probe ø6x-50mm cable length 2m		

solenoid valves

solenoid valves (water)

			
1			
GEV No.	370400	Ref. No.	K01213
description	solenoid valve single angled 230VAC inlet 3/4" outlet 11.5mm input/ min output 1.5l/min DN10 t.max. 90°C ELBI plastic flow regulating valve outlet white		



TP

solenoid valves with reducers

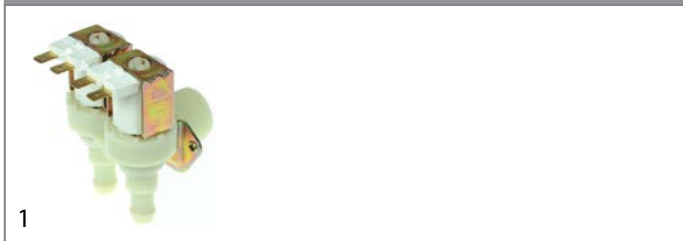

GEV No.	370398	Ref. No.	K01195
description	solenoid valve double angled 230VAC inlet 3/4" input 12l/min t.max. 90°C TP plastic flow regulating valve inlet blue outlet 11.5mm output A 2.5l/min output B 2.5l/min flow regulating valve outlet A yellow flow regulating valve outlet B yellow		



GEV No.	370395	Ref. No.	K01045 K01046
description	solenoid valve double angled 230VAC inlet 3/4" input/min output 0.8/0.8l/min DN10 t.max. 90°C TP plastic outlet 11.5mm output A 0.8l/min output B 0.8l/min flow regulating valve outlet A white flow regulating valve outlet B white		

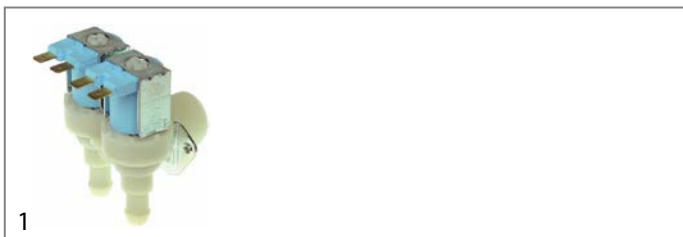

GEV No.	370397	Ref. No.	K01322
description	solenoid valve double angled 230VAC inlet 3/4" input/min output 1.5/2.5l/min DN10 t.max. 90°C TP plastic outlet 11.5mm flow regulating valve outlet A light brown flow regulating valve outlet B yellow		



GEV No.	370396	Ref. No.	K00204
description	solenoid valve double angled 230VAC inlet 3/4" t.max. 90°C TP plastic flow regulating valve inlet white outlet 11.5mm output A 1.5l/min output B 1.5l/min flow regulating valve outlet A light brown flow regulating valve outlet B light brown		

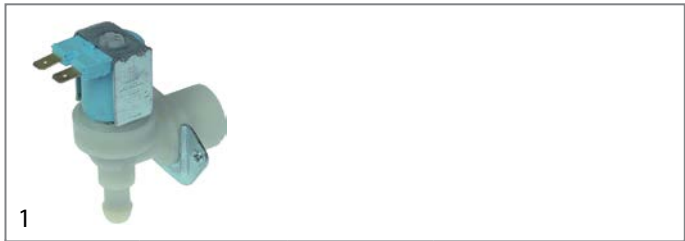

GEV No.	370399	Ref. No.	K01212
description	solenoid valve single angled 230VAC inlet 3/4" outlet 11.5mm input/min output 0.8l/min DN10 t.max. 90°C TP plastic		

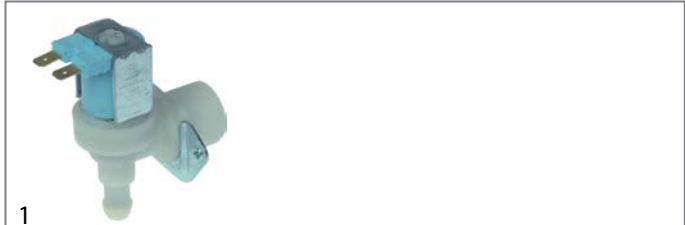

GEV No.	370401	Ref. No.	K01214
description	solenoid valve single angled 230VAC inlet 3/4" outlet 11.5mm output 2.5l/min t.max. 90°C TP plastic flow regulating valve outlet yellow		

solenoid valves (refrigeration)

CASTEL valves



GEV No.	370402	Ref. No.	K01531
description	solenoid valve CASTEL type 1028/2 230V p max 45bar 1/4" connection 1/4" -35 up to 110°C refrigeration copper/brass DN 6.35mm		

spare parts and accessories



GEV No.	371041	Ref. No.	K01381
description	solenoid coil CASTEL 240VAC 8VA 50/60Hz seat ø 11.5mm connection DIN 43650A type HM2		

accessories for	371041		
------------------------	--------	--	--

	GEV No.	371090	Ref. No.	—
		power socket plug type DIN 43650A screw		

	GEV No.	371092	Ref. No.	—
		power socket plug type DIN large cable length 1000mm		



pressure switches

for refrigeration

RANCO

DWFK series



GEV No.	541853	Ref. No.	K00077 K00077+K01106+K00489 K02908+K01106+K00489 K02908+K01106+K01078
description	pressure control RANCO type HR10811A4R001 switching diff.bar pressure range 17.5bar		

SAGI NO MIYA



GEV No.	541120	Ref. No.	K00077
description	pressure control HD reset automatic refrigeration type HTB-X3028 connection male faston 6.3mm switch-on pressure 17bar		

compressors

EMBRACO / ASPERA



R404a/R507

HMBP monophase

High/Medium evaporation temperature above -20/-15 °C



GEV No.	605132	Ref. No.	K00475
description	compressor coolant R404a/R507 type NT6222GK 200-240V 50Hz HMBP fully hermetic 17kg 1HP cylinder capacity 17.39cm ³ CSR H 252mmWW 810W 1032W 1040W 1174W 1307W 1583W 2247W test method ASHRAE		
accessories for	605132		
	GEV No.	365142	Ref. No. —
	operating capacitor capacity 15µF 450V with metal case tolerance 5% 50/60Hz ø 40mm L 110mm M8x1.25		

accessories for	605132		
	GEV No.	365153	Ref. No. —
	starting capacitor 52µF 330V 50/60Hz duty cycle 3s 41280A133 2252347 ø 36mm L 83mm M8 plastic connection cable 350mm		
	GEV No.	390981	Ref. No. —
	klixon suitable for NT6222GK		

L'UNITE HERMETIQUE / TECUMSEH

R404A

HMBP monophase

High/Medium evaporation temperature above -20/-15 °C



GEV No.	605025	Ref. No.	K01186
description	compressor coolant R404A type AE4430Z-FZ 220-240V 50Hz HMBP fully hermetic 10.2kg 1/4HP power input 427W cylinder capacity 5.7cm ³ CSIR H 186mmWW 258W 346W 441W 550W 682W 794W test method EN 12900 908W		
spare parts for	605025		
	GEV No.	380061	Ref. No. —
	start relay MTRP0027-31 120/240V voltage AC 8A 1NO		



GEV No.	605023	Ref. No.	K00085
description	compressor coolant R404A type AE4450Z 220-240V 50Hz HMBP fully hermetic 12.5kg 3/8HP cylinder capacity 8.85cm ³ CSIR H 207mmWW 434W 567W 734W 927W 1270W 1367W test method EN 12900 1729W		



1

GEV No.	605021	Ref. No.	K00200
description	compressor coolant R404A type AEZ4425Z 220-240V 50Hz HMBP fully hermetic 9.8kg 1/5HP cylinder capacity 4.5cm ³ CSIR H 186mmWW 198W 263W 341W 432W 537W 629W test method EN 12900 723W		



1

GEV No.	605022	Ref. No.	K00202
description	compressor coolant R404A type AEZ4440Z 230V 50Hz HMBP fully hermetic 21kg cylinder capacity 7.55cm ³ CSIR H 292mm 415W 517W 637W 772W 919W 1074W test method EN 12900 1234W		



1

GEV No.	605027	Ref. No.	K00476
description	compressor coolant R404A type CAJ4517Z 220-240V 50Hz HMBP fully hermetic 24kg 1.2HP cylinder capacity 25.95cm ³ CSR H 282mmWW 1588W 1987W 2451W 2971W 3536W 4132W test method EN 12900 4742W		



1

GEV No.	605026	Ref. No.	K00206
description	compressor coolant R404A type CAJ9480Z 220-240V 50Hz HMBP fully hermetic 22kg 3/4HP cylinder capacity 15.2cm ³ CSR H 271mm 393W 571W 774W 1009W 1284W 1607W 1989W 2334W test method EN 12900 2699W		



1

GEV No.	605032	Ref. No.	K00475 old
description	compressor coolant R404A type CAJ9510Z 220-240V 50Hz HMBP fully hermetic 23kg 1HP cylinder capacity 18.3cm ³ CSR H 282mm 527W 732W 970W 1252W 1583W 1972W 2437W 2826W test method EN 12900 3220W		

fans

refrigeration fans

refrigeration motors universal

accessories

fan wheels

aluminium

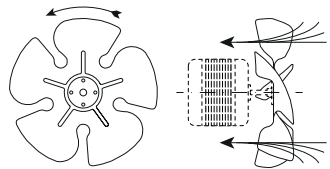
1

GEV No.	601566	Ref. No.	K01301
description	fan wheel sucking ø 154mm fan wheel mounting 25.4mm blade angle 28° W 34mm aluminium		

plastic



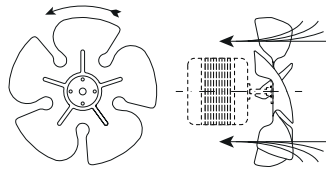

1

GEV No.	601395	Ref. No.	K01023
description	fan wheel sucking ø 154mm fan wheel mounting 25.4mm blade angle 28° W 32mm plastic		

cooling motors (complete)



GEV No.	601396	Ref. No.	K01380
description	fan 230V 10W 50/60Hz fan wheel ø 172mm shaft L 16mm feet depth 53mm L 66mm W 83mm H 83mm blade angle 32° connection cable 500mm		
spare parts for	601396		
	GEV No.	601553	Ref. No. —
	fan wheel sucking ø 172mm fan wheel mounting 25.4mm blade angle 28° W 35mm aluminium		



GEV No.	601397	Ref. No.	K01083
description	fan 230V 10W 50Hz fan wheel ø 154mm shaft L 125mm feet depth 72mm blade angle 28° connection cable 1000mm		

motors

gear motors

for ice-cube maker

for paddles



GEV No.	500422	Ref. No.	606003
description	gear motor ITV type MT6b-GB5FS 3.5W 230V 50Hz 30rpm shaft ø 6mm L 64mm W 51mm H 40mm for ice-cube maker		



GEV No.	500407	Ref. No.	601039
description	gear motor LIP type 123MR 8W 220/240V voltage AC 50/60Hz 50rpm turn direction counterclockwise shaft ø 4mm shaft intake ø 6.2mm groove width 2.3mm shaft L 8mm shaft ø 4mm W 74mm		

for sumps



GEV No.	500412	Ref. No.	601040
description	gear motor LIP type 021B 11W 230V 50Hz 1rpm shaft ø 7mm shaft length 20mm W 74mm D 67mm H 110mm for sump		

pumps

pumps for ice machines



GEV No.	501494	Ref. No.	K02941
description	pump GRE 100W 230V 50Hz inlet ø 24mm outlet ø 21mm L 227mm		



GEV No.	500200	Ref. No.	K01530
description	pump GRE 100W 230V 50Hz inlet ø 24mm outlet ø 23mm L 145mm rotation direction right		





1

GEV No.	500587	Ref. No.	K00553 K01206
description	pump OLYMPIA type L63.T19ICE 190W 230V 50Hz inlet ø 28mm outlet ø 26mm impellor ø 48mm L 200mm rotation direction right for ice-cube maker capacitor 5µF		
spare parts for	500587		
	GEV No.	601395	Ref. No. K01023
	fan wheel sucking ø 154mm fan wheel mounting 25.4mm blade angle 28° W 32mm plastic		



1

GEV No.	500963	Ref. No.	K01164 K01207
description	pump OLYMPIA type T.19 190W 230V 50Hz inlet ø 28mm outlet ø 26mm impellor ø 65mm L 200mm rotation direction right for ice-cube maker capacitor 5µF		
spare parts for	500963		
	GEV No.	601566	Ref. No. K01301
	fan wheel sucking ø 154mm fan wheel mounting 25.4mm blade angle 28° W 34mm aluminium		



1

GEV No.	500161	Ref. No.	600062
description	pump REBO type NR40 55W 230V 50Hz outlet ø 17mm L 110mm rotation direction left for ice-cube maker		
spare parts for	500161		
	GEV No.	500970	Ref. No. —
	pump motor 55W 230V 50Hz REBO L 205mm type outlet ømm suitable for for ice maker		

equipment-specific units

for ice-cube maker

drain systems

drain fittings



1

GEV No.	695350	Ref. No.	K00004
description	drain fitting thread M28x2 L 23mm straight for ice maker		



1

GEV No.	695347	Ref. No.	K00006
description	drain fitting thread M32x1.5 L 49.3mm straight connection 15mm for ice maker		

overflow pipes



1

GEV No.	695346	Ref. No.	K01317
description	overflow pipe for ice maker tube ø 2.6mm pipe length 95.5mm		

spray systems

KASTEL

spray arms



1

GEV No.	694716	Ref. No.	K02896
description	spray arm L 290mm nozzles 6 plastic for ice maker		



1

GEV No.	695330	Ref. No.	K00171 K02205
description	spray arm L 290mm nozzles 6 stainless steel for ice maker		



1

GEV No.	695329	Ref. No.	K00825 K02203 K02897
description	spray arm L 335mm nozzles 6 for ice maker		

			
1			
GEV No.	750391	Ref. No.	K04293
description	spray arm L 445mm nozzles 10 for ice maker		

			
1			
GEV No.	695331	Ref. No.	K00133 K02207
description	spray arm L 445mm nozzles 9 for ice maker		

			
1			
GEV No.	696627	Ref. No.	K02898
description	spray arm L 445mm nozzles 9 for ice maker		

			
1			
GEV No.	695332	Ref. No.	K00047 K02209 K02899
description	spray arm L 675mm nozzles 15 for ice maker		

			
1			
GEV No.	695333	Ref. No.	K00316 K02211 K02900
description	spray arm L 725mm nozzles 18 for ice maker		

accessories

			
1			
GEV No.	695335	Ref. No.	K00527
description	end cap for ice maker		

doors

			
1			
GEV No.	696662	Ref. No.	K03401
description	door for ice maker W 297mm H 197mm thickness 24mm blue		

			
1			
GEV No.	696663	Ref. No.	K04158
description	door for ice maker W 297mm H 197mm thickness 24mm grey		

			
1			
GEV No.	695307	Ref. No.	K00816
description	door for ice-cube maker W 303mm H 185mm thickness 22mm		

			
1			
GEV No.	695306	Ref. No.	K00828
description	door for ice-cube maker W 303mm H 185mm thickness 23mm		

			
1			
GEV No.	695308	Ref. No.	K00241
description	door for ice-cube maker W 337mm H 215mm thickness 23mm		

			
1			
GEV No.	695309	Ref. No.	K00245
description	door for ice-cube maker W 447mm H 215mm thickness 23mm		



1

GEV No.	695310	Ref. No.	K00249
description	door for ice-cube maker W 677mm H 315mm thickness 23mm		



1

GEV No.	695311	Ref. No.	K00456
description	door for ice-cube maker W 725mm H 315mm thickness 23mm		

curtains

with holder



1

GEV No.	695300	Ref. No.	K00826
description	curtain for ice maker W 283mm H 160mm with holder shaft length 260mm shaft \varnothing 7.5mm		



1

GEV No.	695301	Ref. No.	K00225
description	curtain for ice maker W 320mm H 160mm with holder shaft length 310mm shaft \varnothing 7.5mm		



1

GEV No.	695302	Ref. No.	K00653
description	curtain for ice maker W 432mm H 160mm with holder shaft length 430mm shaft \varnothing 7.5mm		



1

GEV No.	695303	Ref. No.	K00556
description	curtain for ice maker W 660mm H 160mm with holder shaft length 660mm shaft \varnothing 7.5mm		



1

GEV No.	695304	Ref. No.	K00227
description	curtain for ice maker W 720mm H 202mm with holder shaft length 705mm shaft \varnothing 7.5mm		

accessories

lamellas



1

GEV No.	695305	Ref. No.	K00008
description	lamella for curtain L 70mm W 25mm ID \varnothing 8mm		

suction system

intake filters



1

GEV No.	695341	Ref. No.	K00012
description	intake filter L 60mm \varnothing 28mm		

pipes



1

GEV No.	695344	Ref. No.	K0058
description	aspiration tube		

gaskets

miscellaneous



1

GEV No.	695348	Ref. No.	K00536
description	sealing ring rubber ED ø 42mm ID ø 33mm thickness 2mm Qty 1 pcs		



1

GEV No.	695351	Ref. No.	K00003
description	sealing ring rubber ED ø 45mm ID ø 27mm thickness 2mm Qty 1 pcs		

hoses

formed hoses

straight

miscellaneous



1

GEV No.	695327	Ref. No.	K00311
description	formed hose straight for ice-cube maker ID ø 17mm ED ø 25mm L 100mm		

form L



1

GEV No.	695314	Ref. No.	K00824
description	formed hose L-shape for ice-cube maker ID ø 17/23mm ED ø 26/30mm L 220mm W 60mm		



1

GEV No.	695328	Ref. No.	K00048 K03462
description	formed hose L-shape for ice-cube maker ID ø 17mm ED ø 24mm L 90mm W 50mm		



1

GEV No.	695326	Ref. No.	K00444
description	formed hose L-shape for ice-cube maker ID ø 17mm ED ø 25mm L 115mm W 50mm		



1

GEV No.	695325	Ref. No.	K00445
description	formed hose L-shape for ice-cube maker ID ø 17mm ED ø 25mm L 195mm W 80mm		

form S



1

GEV No.	695312	Ref. No.	K00110
description	formed hose S-shape for ice-cube maker ID ø 22mm ED ø 30mm L 88mm W 50mm		

form U

group 1



1

GEV No.	695318	Ref. No.	K00141
description	formed hose U-shape for ice-cube maker ID ø 17/25mm ED ø 26/32mm L 300mm W 110mm		



1

GEV No.	695316	Ref. No.	K00184
description	formed hose U-shape for ice-cube maker ID ø 17/26mm ED ø 26/32mm L 220mm W 100mm		



1

GEV No.	695320	Ref. No.	K00197
description	formed hose U-shape for ice-cube maker ID ø 17/26mm ED ø 26/32mm L 410mm W 120mm		





1

GEV No.	695324	Ref. No.	K00217
description	formed hose U-shape for ice-cube maker ID ø 17/26mm ED ø 26/32mm L 620mm W 130mm		





			
1			
GEV No.	695322	Ref. No.	K00109
description	formed hose U-shape insulated for ice-cube maker ID ø 17/25mm ED ø 26/32mm L 530mm W 130mm		

group 2			
			
1			
GEV No.	695313	Ref. No.	K00823
description	formed hose U-shape for ice-cube maker ID ø 17/23mm ED ø 26/32mm L 250mm W 60mm		

			
1			
GEV No.	695315	Ref. No.	K00185
description	formed hose U-shape for ice-cube maker ID ø 17/26mm ED ø 26/32mm L 280mm W 80mm		

			
1			
GEV No.	695319	Ref. No.	K00198
description	formed hose U-shape for ice-cube maker ID ø 17/26mm ED ø 26/32mm L 460mm W 100mm		

			
1			
GEV No.	695321	Ref. No.	K00072
description	formed hose U-shape for ice-cube maker ID ø 17/26mm ED ø 26/32mm L 550mm W 100mm		

			
1			
GEV No.	695323	Ref. No.	K00218
description	formed hose U-shape for ice-cube maker ID ø 17/26mm ED ø 26/32mm L 670mm W 100mm		

			
1			
GEV No.	695317	Ref. No.	K00142
description	formed hose U-shape for ice-cube maker ID ø 26/17mm ED ø 26/32mm L 350mm W 85mm		

hose connectors

with thread

			
1			
GEV No.	695352	Ref. No.	K00039
description	hose connector for drain assembly		

without thread

			
1			
GEV No.	695336	Ref. No.	K00578
description	hose connector		

			
1			
GEV No.	695337	Ref. No.	K00001
description	hose connector		

			
1			
GEV No.	695340	Ref. No.	K01805
description	hose connector		

			
1			
GEV No.	695339	Ref. No.	K01806
description	hose connector for hose ID 23-10-10-23mm plastic Qty 1 pcs		

floats

float containers



1

GEV No.	695073	Ref. No.	601002
description	float container		
spare parts for	695073		
	GEV No.	346872	Ref. No. 601003
	microswitch with lever 250V 0.1A 1CO connection male faston 6.3mm L 50mm ambient temperature max. 85°C mounting distance 22mm type D41X actuating force: 6g lever length 36mm		



1

GEV No.	402163	Ref. No.	K03054
description	float container L 150mm 250V cable lengthmm ømm mounting ømm 2CO 12A male faston 6.3mm		
spare parts for	402163		
	GEV No.	348044	Ref. No. —
	microswitch with plunger 250V 16A 1CO connection male faston 4.8mm Lmm L1 27.8mm ambient temperature max. 125°C mounting distance 22mm with lever set type MS1-16 actuating force: 45g white		

miscellaneous



1

GEV No.	695349	Ref. No.	K01126
description	nut H 7mm thread M32x1.5 plastic WS 41 Qty 1 pcs		



1

GEV No.	695345	Ref. No.	K00057
description	pipe for inlet		

equipment feet and end caps

screw-in feet



1

GEV No.	695353	Ref. No.	K01086
description	equipment foot thread L 17mm ø 18mm H 40mm WS 24 Qty 1 pcs		

gaskets

O-rings

EPDM

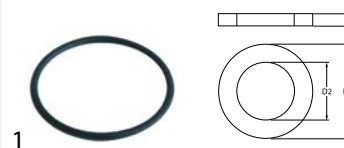

1

GEV No.	510447	Ref. No.	K03089
description	O-ring EPDM thickness 5.34mm ID ø 81.92mm Qty 1 pcs		

silicone

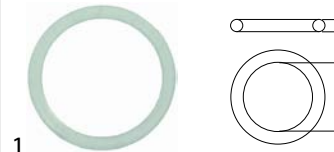

1

GEV No.	532517	Ref. No.	K01125
description	O-ring silicone thickness 1.78mm ID ø 17.17mm Qty 1 pcs		

sealing washers

rubber gaskets



1

GEV No.	695348	Ref. No.	K00536
description	sealing ring rubber ED ø 42mm ID ø 33mm thickness 2mm Qty 1 pcs		



1

GEV No.	695351	Ref. No.	K00003
description	sealing ring rubber ED ø 45mm ID ø 27mm thickness 2mm Qty 1 pcs		



refrigeration cycle components

cooling water regulators

JOHNSON CONTROLS



1

GEV No.	541186	Ref. No.	K00497
description	cooling water regulator 3/8" type V46SA-9951 connection 6mm soldering connection pressure range 5-23bar water pressure max. 18bar water temperature max. 90°C capillary pipe 750mm L 101mm		

filter driers

CASTEL

STANDARD series

suitable for refrigerants R12, R22, R134a, R404A, R407C, R410A, R502, R507



1

GEV No.	750038	Ref. No.	K00081
description	dryer type 4303/2S connection ODS 1/4"-ODM 3/8" 50cm ³ p max 45bar -40 up to +80°C		



1

GEV No.	750039	Ref. No.	K00478
description	dryer type 4305/2S connection ODS 1/4"-ODM 3/8" 80cm ³ p max 45bar -40 up to +80°C 254g		

miscellaneous



1

GEV No.	750222	Ref. No.	K00199
description	dryer size 15g ø 18.9mm L 119mm connection 2,4/6,7mm		

evaporators

for ice-cube maker

for ice cube maker



1

GEV No.	750191	Ref. No.	K00332
description	evaporator for ice-cube maker 108 cubes L 780mm W 275mm H 42mm KP130/75-KP160/75		



1

GEV No.	750188	Ref. No.	K00145
description	evaporator for ice-cube maker 24 cubes L 330mm W 198mm H 40mm KP21/5-KP30/10		



1

GEV No.	750189	Ref. No.	K00139
description	evaporator for ice-cube maker 36 cubes L 445mm W 198mm H 42mm KP44/15-KP50/26		



1

GEV No.	750390	Ref. No.	K04122
description	evaporator for ice-cube maker 40 cubes L 445mm W 198mm H 45mm		



1

GEV No.	750190	Ref. No.	K00138 K04291+K04123
description	evaporator for ice-cube maker 60 cubes L 673mm W 198mm H 45mm KP75/40-KP100/60		

hoses

industrial hoses

PVC hoses

PVC braided hoses

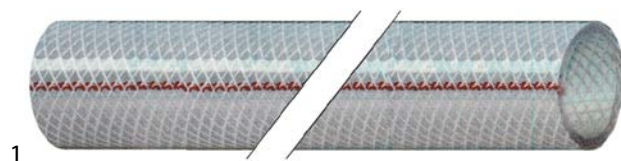

1

GEV No.	530564	Ref. No.	K00073
description	PVC braided hose ID ø 10mm ED ø 16mm L 10m thickness 3mm operating p. 10bar burst p. 30bar t.max. 60°C		

PVC hoses without fabric

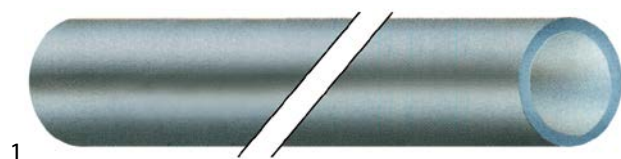

1

GEV No.	530721	Ref. No.	00003297 K00541 K01209
description	PVC hose ID ø 13mm ED ø 19mm L 5m thickness 3mm transparent		

fittings, hose and pipe connectors

hose connectors

without screw connection



1

GEV No.	517166	Ref. No.	K00010
description	Y-piece plastic hose ø 10-10-10mm 3-way		



1

GEV No.	695343	Ref. No.	K00230
description	T-piece plastic hose ø 19-19-19mm 3-way		



hose connectors

producer-specific

1 

GEV No.	695336	Ref. No.	K00578
description	hose connector		

1 

GEV No.	695337	Ref. No.	K00001
description	hose connector		

1 

GEV No.	695340	Ref. No.	K01805
description	hose connector		

1 

GEV No.	695339	Ref. No.	K01806
description	hose connector for hose ID 23-10-10-23mm plastic Qty 1 pcs		

fastening material

screws

knurled screws

1 

GEV No.	695354	Ref. No.	K00013
description	Thumb screw thread M4 thread L 10mm ø 10mm H 6mm SS		

