



**GAS COMPONENTS**



**ELECTRIC COMPONENTS**



**WATER TECHNOLOGY**



**MECHANICAL COMPONENTS**



**TOOLS**

Spare parts suitable for

**SOGECO**

Find the complete and up-to-date range of products in our GEV Webshop



# Manufacturer catalogue

The most important spare parts and accessories arranged clearly for every manufacturer

- ✓ Complete product range and all appliance data always up to date in the GEV Webshop
- ✓ Alphabetical Index at the end of the catalogue

## GEV Webshop

[www.gev-online.co.uk](http://www.gev-online.co.uk)

[www.gev-online.com](http://www.gev-online.com)



- 🔍 Add to Favourites
- 🔍 Sign In with email address and usual password
- 🔍 Easy-order – place several items in your basket at the same time
- 🔍 Quick Item search – no login needed



## heating elements

### heating elements for convection

			
1			
<b>GEV No.</b>	418487	<b>Ref. No.</b>	03-RST-3C15
<b>description</b>	heating element 3150W 230V heating circuits 3 ID ø 201mm ED ø 218mm L 275mm H 41mm L1 54mm W1 63mm H1 3mm H2 38mm flange length 93mm flange width 22mm hole distance 78mm connection male faston 6.3mm connection length 65mm tube ø 8.5mm convection heating element hole ø 5mm rectangular flange		

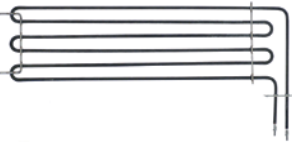
			
1			
<b>GEV No.</b>	419235	<b>Ref. No.</b>	03-RST-3B50 RES202.12011
<b>description</b>	heating element 3500W 230V heating circuits 1 L 560mm W 175mm L1 30mm L2 530mm W2 145mm flange length 70mm flange width 22.5mm hole distance 56mm connection M4 tube ø 6.3mm W1 33mm convection heating element combi-steamer windings 3		

## thermostats

### bi-metal thermostats

			
1			
<b>GEV No.</b>	375927	<b>Ref. No.</b>	03-TRS-050
<b>description</b>	bi-metal thermostat hole distance 23.5mm switch-off temp. 50°C 1NO 10A connection F6.3		

## control and safety thermostats

### EGO

#### control thermostats

#### 55.10/19\_ series



			
1			
<b>GEV No.</b>	375860	<b>Ref. No.</b>	03-THR-270
<b>description</b>	thermostat t.max. 289°C temperature range 57-289°C 1-pole 1NO 16A probe ø 3.1mm probe L 226mm capillary pipe 1780mm capillary pipe isolated 1770mm gland nut shaft ø 6x4.6mm shaft L 23mm shaft position upper rotation 270° probe material SS		

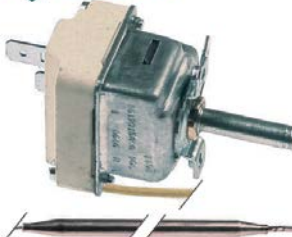

			
1			
<b>GEV No.</b>	375809	<b>Ref. No.</b>	03-THR-090
<b>description</b>	thermostat t.max. 90°C temperature range 30-90°C 1-pole 1NO 16A probe ø 6mm probe L 130mm capillary pipe 1800mm capillary pipe isolated 1800mm gland nut shaft ø 6x4.6mm shaft L 23mm shaft position upper rotation 270°		

### CAEM

#### safety thermostats

			
1			
<b>GEV No.</b>	375456	<b>Ref. No.</b>	03-TRS-350
<b>description</b>	safety thermostat switch-off temp. 335°C 2-pole 20A probe ø 3mm probe L 200mm capillary pipe 1050mm capillary pipe isolated 650mm gland nut probe SS at 250V 20A at 400V 10A		

## switches and momentary switches

### push/momentary push switches

19x13mm



<b>GEV No.</b>	346542 <sup>1</sup>	<b>Ref. No.</b>	03-INT-B01 Interruttore 001
<b>description</b>	push switch mounting measurements 19x13mm yellow 2NO 250V 16A illuminated connection male faston 4.8mm ambient temperature max. 85°C protection IP40		

**accessories for** 346542



<b>GEV No.</b>	346541	<b>Ref. No.</b>	—
<b>description</b>	protective cover for rocker switch external size 23.4x17.4mm internal size 19x13mm H 9.5mm mounting measurementsmm		

<sup>1</sup>illuminated

ø16mm



<b>GEV No.</b>	346287 <sup>1</sup>	<b>Ref. No.</b>	03-IPLS-001
<b>description</b>	momentary push switch mounting ø 16mm red 1NO 250V 3A illuminated connection male faston 2.8mm ambient temperature max. 125/55°C protection IP65 with cover cap		

<sup>1</sup>illuminated



<b>GEV No.</b>	346315	<b>Ref. No.</b>	03-PLS-001 PULSANTE001
<b>description</b>	momentary push switch mounting ø 16mm red 1NO/indicator light 250V 3A connection male faston 2.8mm ambient temperature max. 85°C protection IP40		

**accessories for** 346315



protective cover



ring for protecting cover

ø25mm



<b>GEV No.</b>	345162 <sup>1</sup>	<b>Ref. No.</b>	03-INT-B03
<b>description</b>	push switch mounting ø 25mm yellow 2NO 250V 16A illuminated connection male faston 6.3mm ambient temperature max. 85°C protection IP40		

<sup>1</sup>illuminated

## microswitches

### pin-plunger actuated

M10



<b>GEV No.</b>	345156	<b>Ref. No.</b>	MICROSWITCH001
<b>description</b>	microswitch with plunger thread M10x1 thread L 13mm 250V 16A 1CO connection male faston 6.3mm stroke 6mm mounting distance 25mm L 46mm L1 13mm ambient temperature max. 85°C type C4A-ZN3 actuating force: 340g		

## cam switches

### 2 operating positions

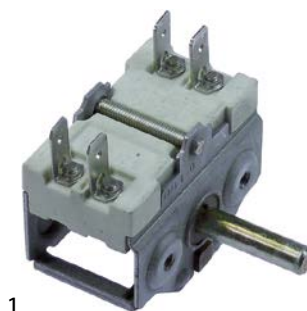

<b>GEV No.</b>	300216	<b>Ref. No.</b>	03-CMM-001
<b>description</b>	cam switch 2 operating positions 2NO sequence 1-2 10A shaft ø 6x4.6mm shaft L 23mm connection male faston 6.3mm ceramic		

## control equipment

### ERSCE

### rotary switches



<b>GEV No.</b>	346691	<b>Ref. No.</b>	SELETTORE001
<b>description</b>	rotary selector mounting measurements ø22mm black complete 1 latching / 2 momentary sequence 1-0-2 2NO/1NO 10(4)A max 400V		

## lamps

### indicator lights

indicator lights (complete)

ø13mm

with plug-in socket



1

<b>GEV No.</b>	359143	<b>Ref. No.</b>	SPIA001
<b>description</b>	indicator light ø 13mm yellow 230V connection male faston 6.3mm temp.-resist. 120°C Qty 1 pcs		

## timers

### programme timers



1

<b>GEV No.</b>	360394	<b>Ref. No.</b>	03-CCL-001 alt Ciclico 001 alt
<b>description</b>	timer CDC 6004F engines 1 chambers 4 operation time 240s 230V		



1

<b>GEV No.</b>	360511	<b>Ref. No.</b>	03-CCL-001 CICALICO001
<b>description</b>	timer FIBER P19 engines 1 chambers 4 operation time 270s 230V shaft ømm shaft Lmm manuf. no. P195JV4H700 motor type M51B-J0R6400		
<b>For models:</b>	MX2011E-S, MX2011G-S, MX20E-S, MX20G-S, MX40E-S, MX40G-S, MX56E-S, MX56G-S, MX6E-S, MX6G-S, MX810E-S, MX810G-S, PMX2011E-S, PMX2011G-S, PMX20E-S, PMX20G-S, PMX40E-S, PMX40G-S, PMX56E-S, PMX56G-S, PMX6E-S, PMX6G-S, PMX810E-S, PMX810G-S		

## electric timers





1

<b>GEV No.</b>	350197	<b>Ref. No.</b>	TIMER006#
<b>description</b>	timer M11 operation time 120min time spreadmin 1CO/1NO at 250V 16A permanent position yes impulse electric shaft ø 6x4.6mm shaft L 23mm mounting distance 28mm connection lateral 2-pole		

## mechanical timers



1

<b>GEV No.</b>	350030	<b>Ref. No.</b>	03-TMR-002 TIMER002
<b>description</b>	timer M2 2-pole operation time 120min impulse mechanical 2NO at 250V 16A permanent position no shaft ø 6x4.6mm shaft L 23mm mounting distance 28mm connection lateral		
<b>accessories for</b>	350030		
	<b>GEV No.</b>	110366	<b>Ref. No.</b> —
	knob switch zero mark t.max.°C ø 44mm shaft ø 6x4.6mm shaft flat upper black		
	<b>GEV No.</b>	111199	<b>Ref. No.</b> —
	dial plate graduation 120min permanent position no rotation 0-330° ø 60mm timers knob ø 45mm		

## alarm devices

### buzzer boards



1

<b>GEV No.</b>	350106	<b>Ref. No.</b>	TIMER003
<b>description</b>	buzzer board 230VAC L 53mm W 31mm connection male faston 4.8mm		



## contactors

## GENERAL ELECTRIC (AEG)

## power contactors



1



<b>GEV No.</b>	380239	<b>Ref. No.</b>	03-CNT-25230
<b>description</b>	power contactor resistive load 20A 230VAC (AC3/400V) 8.4A/4kW main contacts 3NO auxiliary contacts 1NC connection screw connection type LS05 01A type AEG LS05 01A type GE MC1A 301A		

## relays

## plug-in/print relays



1

<b>GEV No.</b>	380847	<b>Ref. No.</b>	03-REL-001 Rele 001
<b>description</b>	relay 230VAC at 250V 8A with socket		
<b>spare parts for</b>	380847		
	<b>GEV No.</b>	380333	<b>Ref. No.</b> —
	print relay 230VAC 2CO at 250V 8A connection pins raster size 5mm FINDER manuf. no. 40.52.8.230.0000 95.65/95.75		
	<b>GEV No.</b>	380505	<b>Ref. No.</b> —
	relay socket 2CO 40.52 dimensions 81.9x15.5x75mm 250V voltage AC 10A FINDER manuf. no. 95.95.3		

## electronic controllers

## EVCO - EVERY CONTROL

## universal controllers

## built-in version



1

<b>GEV No.</b>	378170	<b>Ref. No.</b>	03-THR-001
<b>description</b>	electronic controller EVERY CONTROL EV7402 mounting measurements 66.5x66.5mm built-in depth 90mm 24/230V voltage AC NTC/PTC/Pt100/TC(J,K)/mA relay outputs 2 CO-8A(3) CO-8A(3) NTC/PTC/Pt100/TC(J,K)/mA yes protection IP54 dependend on probe°C display 4 digits		





1

<b>GEV No.</b>	378151	<b>Ref. No.</b>	03-THR-101 03-THR-102 03-THR-104
<b>description</b>	electronic controller EVERY CONTROL EVK412 mounting measurements 71x29mm built-in depth 59mm 12/24V voltage AC/DC NTC/PTC/Pt100/Pt1000/TC(J,K)/mV/mA relay outputs 2 CO-16A(8) CO-8A(3) NTC/PTC/Pt100/Pt1000/TC(J,K)/mV/mA yes protection IP54 dependend on probe°C display 4 digits		



1

<b>GEV No.</b>	379538	<b>Ref. No.</b>	THERMOREC.002A THERMOREC.002C THERMOREC.003
<b>description</b>	electronic controller EVERY CONTROL mounting measurements 71x29mm 12V voltage AC Pt100 protection IP54 -50 up to +600°C for oven type FK401A front measurements 33x75mm		
<b>accessories for</b>	379538		
	<b>GEV No.</b>	379050	<b>Ref. No.</b> —
	temperature probe Pt100 cable Vetrotex probe -200 up to +600°C cable -50 up to +350°C probe ø6x100mm cable length 2.7m without screw connection 3-wire		

1

<b>GEV No.</b>	379537	<b>Ref. No.</b>	TIMER004
<b>description</b>	electronic timer EVERY CONTROL mounting measurements 71x29mm 12V voltage AC/DC type FK700A		

probes

producer-specific probes

probes



1

<b>GEV No.</b>	378011	<b>Ref. No.</b>	03-SNC-1H SONDA021
<b>description</b>	core temperature probe Pt100 cable silicone probe -40 up to +120°C cable -50 up to +180°C connection 2-wire thread probe ø3x150mm cable length 2m		

core probes



1

<b>GEV No.</b>	378010	<b>Ref. No.</b>	03-SNS-1HA SONDA001
<b>description</b>	core temperature probe Pt100 cable SS corrugated hose probe -50 up to +400°C cable -40 up to +250°C connection 3-wire probe ø4x100mm thread 1/8" cable length 1.4m handle ø 10mm handle length 90mm		

pressure switches

for steam control



1

<b>GEV No.</b>	541074	<b>Ref. No.</b>	PRE202.15006 Pressostato001
<b>description</b>	pressure control ø 45mm triggering pressure 0.5bar reset pressure 0.35bar pressure connection vertical steam control pressure range 0.35/0.51bar connection 1/8" pressure connection 1/8"		
<b>For models:</b>	MX2011E-S, MX2011G-S, MX20E-S, MX20G-S, MX40E-S, MX40G-S, MX56E-S, MX56G-S, MX6E-S, MX6G-S, MX810E-S, MX810G-S, PMX2011E-S, PMX2011G-S, PMX20E-S, PMX20G-S, PMX40E-S, PMX40G-S, PMX56E-S, PMX56G-S, PMX6E-S, PMX6G-S, PMX810E-S, PMX810G-S		

fans

axial fans

import





1

<b>GEV No.</b>	601131 <sup>1</sup>	<b>Ref. No.</b>	03-VNR-120.25	
<b>description</b>	axial fan L 119mm W 119mm H 25mm 230VAC 50/60Hz 19/18W bearing ball bearing connection male faston 2.8mm metal ADDA fan wheel ø 110mm temp.-resist. 70°C			
<b>accessories for</b>	601131			
	<b>GEV No.</b>	550898	<b>Ref. No.</b>	—
	connecting cable cable length 2000mm connection F 2.8 connection distance 7.9mm for axial flow fan			

<sup>1</sup>with ball bearings



1

<b>GEV No.</b>	601080 <sup>1</sup>	<b>Ref. No.</b>	03-VNR-120.38	
<b>description</b>	axial fan L 119mm W 119mm H 38mm 230VAC 50/60Hz 23/20W bearing ball bearing connection male faston 2.8mm metal ADDA fan wheel ø 110mm temp.-resist. 70°C			
<b>accessories for</b>	601080			
	<b>GEV No.</b>	550898	<b>Ref. No.</b>	—
	connecting cable cable length 2000mm connection F 2.8 connection distance 7.9mm for axial flow fan			
	<b>GEV No.</b>	692519	<b>Ref. No.</b>	—
	guard L 120mm W 120mm plastic			

<sup>1</sup>with ball bearings



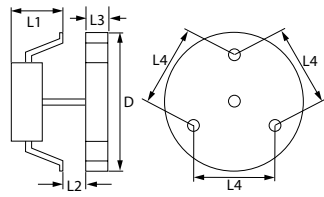

hot air fans

miscellaneous



1

<b>GEV No.</b>	601273	<b>Ref. No.</b>	MOTOVENTILATORE
<b>description</b>	hot air fan 220-240V 32W 50/60Hz L1 60mm L2 10mm L3 25mm L4 87mm fan wheel ø 155mm FIME type C20X0E01/15CLH		



<b>accessories for</b>	101127			
	<b>GEV No.</b>	101303	<b>Ref. No.</b>	—
	gas connection straight thread 3/4" ELETTROSIT			
	<b>GEV No.</b>	101309	<b>Ref. No.</b>	—
	extension			

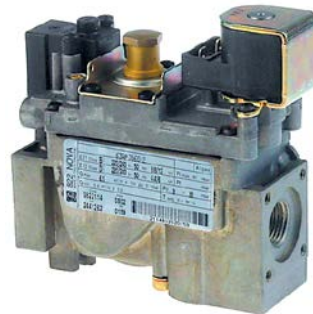





NOVASIT



1

<b>GEV No.</b>	101914	<b>Ref. No.</b>	02-VLV-822
<b>description</b>	gas valve SIT series Novasit 822 230V 50Hz gas inlet 1/2" gas outlet 1/2" thermocouple connection pilot connection closed ignition pressure range 3-30mbar pressure regulator connection blind equiv. no. 0.822.144		

<b>spare parts for</b>	101914			
	<b>GEV No.</b>	101313	<b>Ref. No.</b>	—
	solenoid coil 230V 50Hz			
	<b>GEV No.</b>	101542	<b>Ref. No.</b>	—
	solenoid coil 50Hz NOVA 822/826/827 suitable for NOVASIT 230V			

<b>accessories for</b>	101914			
	<b>GEV No.</b>	101305	<b>Ref. No.</b>	—
	gas connection straight 1/2" flange 45x45mm ELETTROSIT/V4400/4600/4605 suitable for SIT/HONEYWELL hole distance 36x36mm			
	<b>GEV No.</b>	101306	<b>Ref. No.</b>	—
	gas connection angled flange 45x45mm hole distance 36x36mm 1/2" ELETTROSIT/V4400/4600/4605 screw with O-ring suitable for SIT/HONEYWELL			
	<b>GEV No.</b>	101307	<b>Ref. No.</b>	—
	gas connection straight flange 45x45mm hole distance 36x36mm 3/4" ELETTROSIT/V4400/4600/4605 screw with O-ring suitable for SIT/HONEYWELL			
	<b>GEV No.</b>	101308	<b>Ref. No.</b>	—
	gas connection angled flange 45x45mm hole distance 36x36mm 3/4" ELETTROSIT/V4400/4600/4605 screw with O-ring suitable for SIT/HONEYWELL			
	<b>GEV No.</b>	101503	<b>Ref. No.</b>	—
	O-ring EPDM thickness 2mm ID ø 32mm Qty 1 pcs			
	<b>GEV No.</b>	101924	<b>Ref. No.</b>	—
	plug with cable L 1090mm suitable for NOVA 822/826/827			

gas valves and ignition boxes

gas control valves

SIT

ELETTROSIT



1

<b>GEV No.</b>	101127	<b>Ref. No.</b>	VALVOLA002
<b>description</b>	gas valve SIT type ELETTROSIT 230V gas inlet 3/4" gas outlet 3/4" thermocouple connection M9x1 pilot connection M10x1 lateral equiv. no. 0.810.175		

<b>spare parts for</b>	101127			
	<b>GEV No.</b>	101312	<b>Ref. No.</b>	—
	microswitch			
	<b>GEV No.</b>	101352	<b>Ref. No.</b>	—
	solenoid coil 230V 50Hz suitable for ELETTROSIT			
<b>accessories for</b>	101127			
	<b>GEV No.</b>	100006	<b>Ref. No.</b>	—
	piezoelectric igniter suitable for ELETTROSIT body plastic blowing connection ø2.4mm ø 14mm			
	<b>GEV No.</b>	100904	<b>Ref. No.</b>	—
	locking screw M10x1 for pipe ø 4mm Qty 1 pcs			
	<b>GEV No.</b>	100905	<b>Ref. No.</b>	—
	locking screw M10x1 for pipe ø 6mm Qty 1 pcs			
	<b>GEV No.</b>	101301	<b>Ref. No.</b>	—
	gas connection thread 1/2" straight ELETTROSIT screw with O-ring			





## ignition boxes

### BRAHMA



1			
<b>GEV No.</b>	107471	<b>Ref. No.</b>	02-CNT-001 CONTROLO 001
<b>description</b>	ignition box BRAHMA type CM11 electrodes 2 waiting time 1.5s safety time 10s 230V 7VA 50-60Hz		

## ignition parts

### pilot burners

#### producer-specific pilot burners

### SOGECO

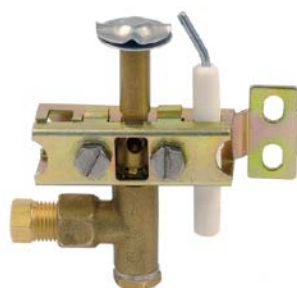

1			
<b>GEV No.</b>	107527	<b>Ref. No.</b>	11-008 FUORIMAGAZZINO
<b>description</b>	pilot burner 3 flames nozzle ø 0.2mm gas connection 6mm		

## gas burners

### bar burners

#### bar burners



1			
<b>GEV No.</b>	103153	<b>Ref. No.</b>	02-BRU-2264 Bruciatore 007
<b>description</b>	bar burner ø 50mm Wmm Hmm L 465mm		

## equipment-specific units

### for convection ovens/combi-steamers

#### glass panels



1			
<b>GEV No.</b>	694847	<b>Ref. No.</b>	00-TVP-002
<b>description</b>	glass panel L 673mm W 510mm H 5mm		

## locks

### handle latches

#### universal

#### outside fixing

#### locks







1				
<b>GEV No.</b>	694065	<b>Ref. No.</b>	N/A	
<b>description</b>	door handle for headed units L 145mm W 40mm H 62mm spring length 33mm outer black			
<b>spare parts for</b>	694065			
	<b>GEV No.</b>	514390	<b>Ref. No.</b>	—
	spring for door handle ø 6mm L 54mm W 27.5mm			
	<b>GEV No.</b>	694734	<b>Ref. No.</b>	—
	door handle L 165mm W 40mm H 25mm black			
	<b>GEV No.</b>	694735	<b>Ref. No.</b>	—
	cap ø 32mm black			
<b>accessories for</b>	694065			
	<b>GEV No.</b>	694066	<b>Ref. No.</b>	—
	door catch with spigot 2-stage L 28mm W 14mm H 15mm H1 16mm total length 51mm thread M8 thread L 23mm stainless steel			
	<b>GEV No.</b>	694067	<b>Ref. No.</b>	—
	door catch with spigot 1-stage L 26mm total length 51mm thread M8			

producer-specific

SOGECO





<b>GEV No.</b>	694065	<b>Ref. No.</b>	N/A
<b>description</b>	door handle for headed units L 145mm W 40mm H 62mm spring length 33mm outer black		
<b>spare parts for</b>	694065		
	GEV No.	514390	Ref. No. —
	spring for door handle $\phi$ 6mm L 54mm W 27.5mm		
	GEV No.	694734	Ref. No. —
	door handle L 165mm W 40mm H 25mm black		
	GEV No.	694735	Ref. No. —
	cap $\phi$ 32mm black		
<b>accessories for</b>	694065		
	GEV No.	694066	Ref. No. —
	door catch with spigot 2-stage L 28mm W 14mm H 15mm H1 16mm total length 51mm thread M8 thread L 23mm stainless steel		
	GEV No.	694067	Ref. No. —
	door catch with spigot 1-stage L 26mm total length 51mm thread M8		



edgmount latches

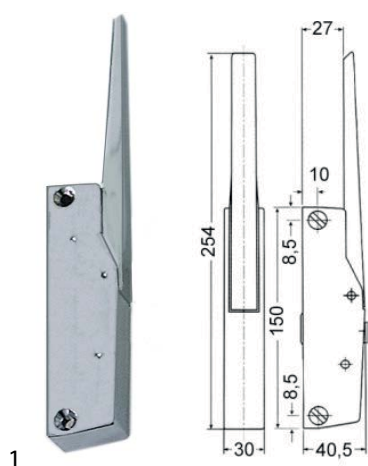

handle latches

CAFF/FERMOD

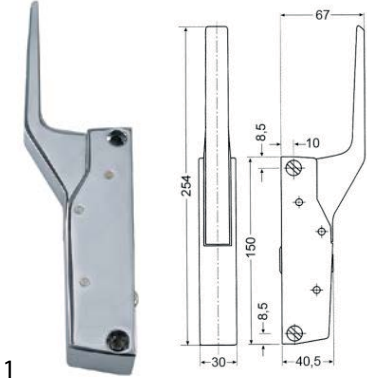

<b>GEV No.</b>	690412	<b>Ref. No.</b>	AGGANCIO001+ CHIUSURA002+
<b>description</b>	handle latch L 150mm mounting distance 133mm non lockable G 790 total length 254mm handle length 105mm		
<b>accessories for</b>	690412		
	GEV No.	690418	Ref. No. —
	door catch L 36mm W 19mm H 29mm mounting distance 12mm zinc-coated steel for refrigeration units		

<b>accessories for</b>	690412		
	GEV No.	690419	Ref. No. —
	door catch L 52mm W 20mm H 30mm mounting distance 26-37mm zamak for refrigeration units		
	GEV No.	700061	Ref. No. AGGANCIO001
	door catch L 58mm W 20mm H 35mm mounting distance 42mm chrome-plated brass for headed units		
	GEV No.	700435	Ref. No. —
	door catch L 58mm W 20mm H 35mm mounting distance 42mm zamak for refrigeration units		

<b>1</b>			
<b>GEV No.</b>	700060	<b>Ref. No.</b>	CHIUSURA002
<b>description</b>	handle latch L 150mm mounting distance 133mm non lockable heated units G 791		
<b>accessories for</b>	700060		
	GEV No.	700061	Ref. No. AGGANCIO001
	door catch L 58mm W 20mm H 35mm mounting distance 42mm chrome-plated brass for headed units		
	GEV No.	700062	Ref. No. —
	handle protection heated units		

door catches



<b>GEV No.</b>	700061	<b>Ref. No.</b>	AGGANCIO001
<b>description</b>	door catch L 58mm W 20mm H 35mm mounting distance 42mm chrome-plated brass for headed units		
<b>accessories for</b>	700061		
	GEV No.	690414	Ref. No. —
	handle latch L 150mm mounting distance 133mm non lockable refrigeration units G 791		

## gaskets

### gaskets for heated units

#### window seals

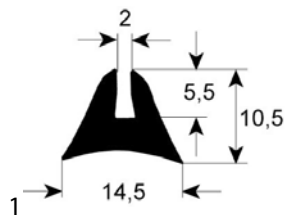

<b>GEV No.</b>	900601	<b>Ref. No.</b>	04-GRN-002 GUARNIZIONE002
<b>description</b>	window gasket profile 1660 Qty supplied by meter		

#### door seals

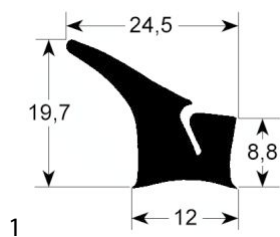

<b>GEV No.</b>	900602	<b>Ref. No.</b>	GUARNIZIONE001
<b>description</b>	door seal profile 2430 Qty supplied by meter		

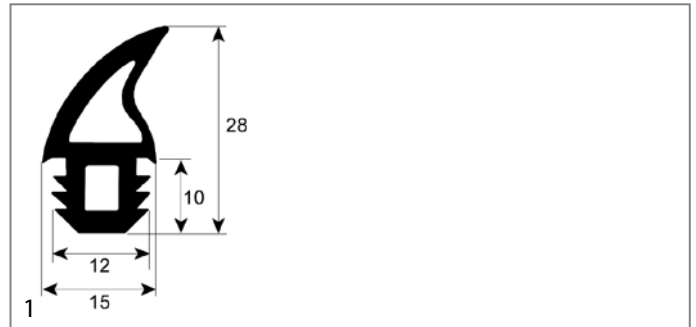

<b>GEV No.</b>	901331	<b>Ref. No.</b>	04-GRN-003
<b>description</b>	door seal profile 2756 Qty supplied by meter		

#### gaskets for tray rack trolleys

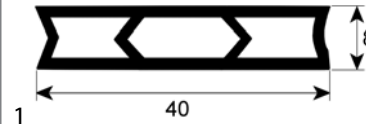

<b>GEV No.</b>	901330	<b>Ref. No.</b>	04-GRN-005
<b>description</b>	tray rack trolley gasket profile 4065 silicone Qty supplied by meter		



<b>A</b>			
alarm devices	5	pressure switches	7
axial fans	7	probes	7
<b>B</b>		programme timers	5
bar burners	9	push/momentary push switches	4
bi-metal thermostats	3, 3	<b>R</b>	
<b>C</b>		relays	6
cam switches	4	<b>S</b>	
contactors	6	switches and momentary switches	4
control equipment	4	<b>T</b>	
control thermostats	3	thermostats	3
<b>D</b>		timers	5
door catches	10	<b>W</b>	
door seals	11	window seals	11
<b>E</b>			
edgemount latches	10		
electric timers	5		
electronic controllers	6		
<b>F</b>			
fans	7		
<b>G</b>			
gas burners	9		
gas control valves	8		
gaskets for heated units	11		
gaskets for tray rack trolleys	11		
<b>H</b>			
handle latches	10		
heating elements	3		
heating elements for convection	3		
hot air fans	8		
<b>I</b>			
ignition boxes	9		
indicator lights	5		
indicator lights (complete)	5		
<b>L</b>			
lamps	5		
<b>M</b>			
mechanical timers	5		
microswitches	4		
<b>P</b>			
pilot burners	9		